



Customer object specifica- tion

KRONES Crate Specifications

Table of Contents

1	General information	3
1.1	Basic information	3
1.2	Application area	3
1.3	Terms	4
2	Dimensional tolerances/permissible deformation	8
2.1	Distribution of tolerances	8
2.2	Outside geometry	9
2.2.1	Example of sample drawing	9
2.2.2	Shape/geometry and dimensional accuracy	9
2.3	Divider geometry	10
2.4	Permissible deformation	11
2.5	Handle geometry	12
3	Geometric characteristics for beverage crates	14
4	Important aspects for avoiding/minimising additional expenditures or processing obstacles	16
4.1	Classification of quality levels and related performance losses	16
4.2	Geometric, material-dependent conditions	18
4.3	Delivery and condition	25
5	Beverage crates with multipacks	30
6	Stackability and palletising	32
6.1	Stackability	32
6.2	Palletising	33
7	Summary	34
	Glossary	35

1 General information

1.1 Basic information

This specification covers so-called empty frames, empty container crates and full container crates. Empty frames are beverage crates without containers. In empty container crates, the containers are in crate packs, however these are not filled, but instead are empty. With mixed empty containers, there may still be liquids in the containers. These liquids can, for example, be residues of the content or rain water. Full container crates are beverage crates with completely filled and closed containers.

To be able to comply with delivery dates and deadlines, samples and drawings of the equipment sold of the sales document will be required in due time. Hand samples and drawings of the beverage crates and container are therefore imperative for the machine design. Commissioning samples are necessary at the point in time of the internal commissioning at Krones. The number of commissioning sample crates must at least correspond to the quantity required for two layer patterns on the pallet. Optional crates are packs which may not be relative for processing until a later point in time. To take this into account for the machine design, information or drawings will already be required for this purpose if available.

Sample crates and the related containers are required for the design of the machines. They must be provided in due time by the customer so that all deadlines and dates can be complied with by Krones. The samples are to correspond to reality. This means that the samples not only consist of new beverage crates. If there are already used beverage crates, they are to be included in the sample product. If various packs have the same dimensions (e.g. 400 mm x 300 mm), all geometric variants of the beverage crates and bottles to be processed on the machine must be provided as samples. This applies even if they only differ slightly in their design, e.g. in the geometry of the handle openings. If newly developed crates are concerned for which the customer itself has no samples yet, then at least a rapid prototyping model should be provided for the machine design.

Beverage crates primarily run through the machine sections of the dry end in the the processing process. The dry end comprises all sections of a bottling line for which the packs are already processed with outer packaging. The functions of these systems are described in the following:

- When returned to the beverage manufacturer, the beverage crates are usually delivered as mixed empty containers stacked in several layers over each other on a pallet. The depalletiser raises these layers off the pallet consecutively and sets them down individually at another location.
- The beverage crates which now form a layer are transported further as a row after the separating table.
- An unpacker lifts the empty containers out of the pack for further processing.
- A packer lifts the washed and filled containers as a group or in a multipack into the pack.
- The beverage crates arriving as a row are brought into a planar arrangement pattern by the grouping station.
- Then these layers are raised by a palletiser onto a pallet and stacked over each other.

1.2 Application area

A large number of requirements must be met in order to achieve process-reliable, automated processing of beverage crates. To avoid additional work and the costs associated with it, packs must meet certain criteria which result from machine processing. This specification explains the requirements necessary for order processing. In the following, crates are specified in accordance with various criteria,

such as tolerances, condition and shape. The effects on the efficiency are illustrated using examples. This serves to ensure the processability and to exclude possible damage to machines, packaging, containers and labels.

The term "Design Freeze" is understood to mean the point in time at which the product design is "frozen" with regard to the order interpretation. This means that all design elements can no longer be changed from this point in time. As soon as the pack is changed by the purchaser following the design freeze, the customer is responsible for informing Kronos AG. This later change must be checked by the Kronos Design department. It is also possible that tests under production-like conditions must be carried out by the customer due to these changes.

The specification is intended to show the processability of beverage crates. This indicates which tolerances, deformations and delivered states are permissible. As soon as beverage crates are outside this specification, performance and processing restrictions are to be expected. Non-availability is also possible. Costs can result from later change to the machine.

Apart from the consideration of individual specifications, the interaction of different specification characteristics can lead to an improvement or worsening. In individual cases, this cannot be determined until processing is carried out. With obvious deviations, these must be named by the customer and checked by the Kronos Design department.

1.3 Terms

Beverage crate:



Fig. 1: Beverage crate

Beverage crates are among the returnable products and will also be called bottle crates, crates or packs in the following. They have many functions. The transport function is important for the end user, but also for handling in processing, e.g. during palletising or depalletising. This includes not only container storage and carrying comfort, but also stackability. The positioning function of the containers of beverage crates is made possible by the interior - dividers. Beverage crates also have a marketing function. This includes the design and brand visibility. Beverage crates are primarily manufactured out of plastic and are reusable. In addition, damaged or old beverage crates can be melted down and injected up to 15 times. Beverage crates made of wood or metal are excluded from this specification due to their scarcity.



Fig. 2: Dividable crate

Some packs also have special functions, such as a dividability of the crate to enable transporting of smaller container units.

Dividers:

Dividers refer to the division inside the beverage crate. It has a positioning function for the containers to be transported. It is intended to fix the containers in their position and to separate the containers from each other. This prevents the containers from striking or touching each other.

Low-side crate:

Low-side crates are beverage crates which are lower than the related containers they contain. If containers are contained in the crate, they do not lock in place as in ordinary beverage crates, but instead as shown in the lower right illustration. A column or group stacking is enabled with corresponding recesses on the underside of the crate base. The stacking function (crate-in-crate) is only given when there are no containers in the beverage crate.



Fig. 3: Low-side crate



Fig. 4: Low-side crates stacked without containers



Fig. 5: Low-side crates stacked with glass bottles

Advertising and additional inserts:

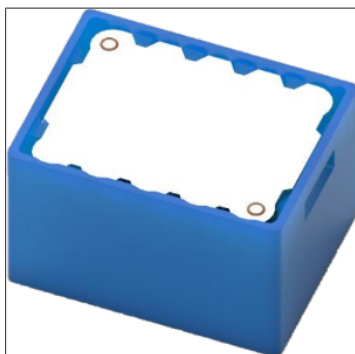

Fig. 6: Beverage crates with sunshield

Advertising and additional inserts must be registered with Sales and in the Design department. The use of such inserts can result in a complete alteration of the gripper design. Among other things, this includes sunshields and advertising inserts, e.g. glasses, flyers or toys. The illustration on the right shows a sunshield.

Multipacks

Multipacks are cardboard containers in which containers have been grouped beforehand. These packs will then be placed in the beverage crate. This enables easier removal of partial quantities for consumers, as they can then transport the removed containers more easily. The arrangement of containers in packs is usually 2x3. With regard to the design, for example Open Basket, Closed Basket, Over-Top Open and On-Top Clips may be concerned.



Fig. 7: Pin-partitioned crate without inserted multipacks



Fig. 8: Pin-partitioned crate with inserted multipacks



Fig. 9: Open Basket



Fig. 10: Closed Basket

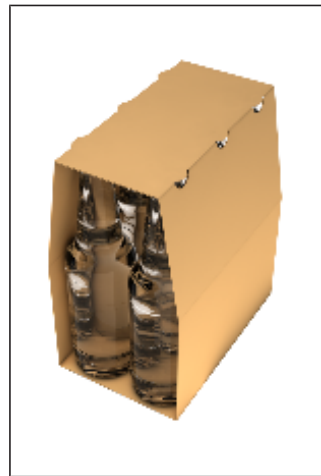

Fig. 11: Over-Top Open



Fig. 12: On-Top Open

Plastic or cardboard trays are not covered in this specification. Fully enveloped cartons which are transported without beverage crates are not considered.



Fig. 13: Cardboard trays

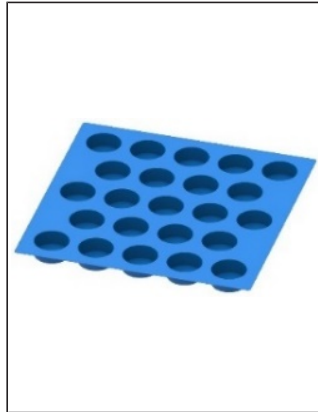

Fig. 14: Plastic trays

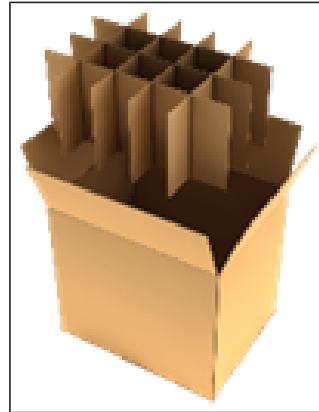

Fig. 15: Fully enveloped cartons

2 Dimensional tolerances/permissible deformation

As the usage and ageing tolerances can differ depending on the various crate pack, the orientation for the machine design is on the customer tolerances. If these are not available, the tolerance values commonly used by the manufacturers can be used for orientation.

Tolerances must always be kept to a minimum in order to avoid causing additional costs. Therefore, when registering a pack, the ageing and usage tolerances are correspondingly important. Newly produced crate products generally have a very close tolerance to the nominal dimension.

If no tolerances are specified on the drawing and the customer is also unable to provide any information on them, the customer must carry out measurements. Depending on the type of beverage crate, optimally at least 20 crates should be measured in order to obtain meaningful results. The length, width and height must be measured. When measuring the length and width, it must be ensured that the dimensions in the area of the base are measured, as the dimensions in this area of the crate are most important for processing. Otherwise we will assume the deviations contained in this specification.

2.1 Distribution of tolerances

A normal distribution can be assumed for a majority of new beverage crates. With a normal distribution, the majority of all crates has a corresponding nominal dimension. This means that beverage crates with larger \pm deviations from the nominal dimension occur more seldom compared to beverage crates which are very close to the nominal dimension. Greatly differing packs are therefore in the minority. Dimensional differences can occur in the positive or negative direction. As a result, the machines will be designed for the nominal dimension due to the varying deviations in the + and - direction of the tolerance range. When simultaneously processing several beverage crates, tolerances can cancel each other out, and seldom amplify each other. Here as well, the design is based on the nominal dimension. Nevertheless, we have to keep an eye on the positive and negative maximum tolerance. If the customer can make a statement regarding a direction of the deviation due to experience or samples, it should inform the Design department via Sales to take this into account when designing the machine.

2.2 Outside geometry

2.2.1 Example of sample drawing

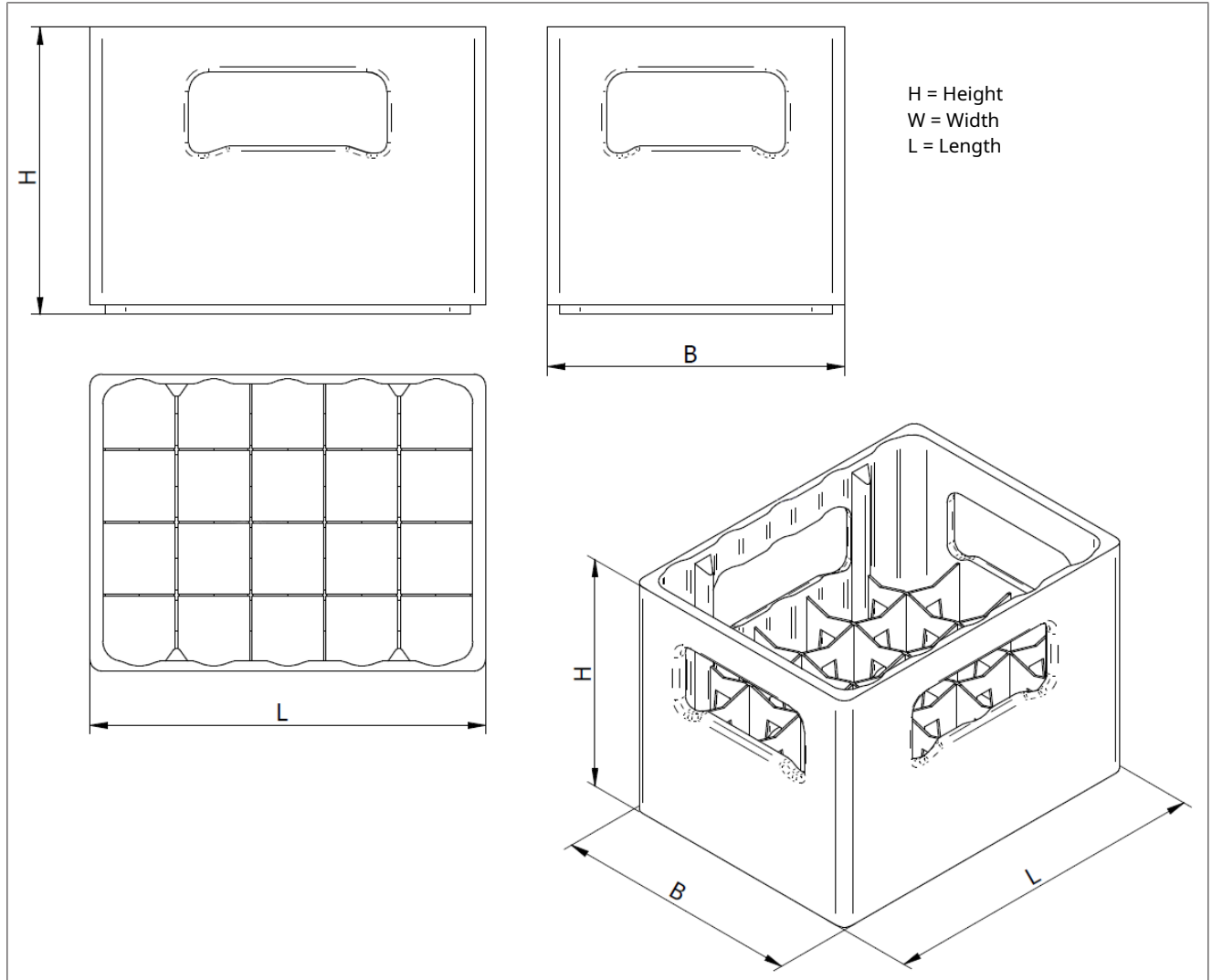

Fig. 16: Sample drawing

2.2.2 Shape/geometry and dimensional accuracy

For the basic dimensions, i.e. length, width and height, the maximum deviation which can still be processed is -0.5% and +0.5%. The following table lists areas and the related tolerances:

Nominal dimension Length L, Width W, Height H in mm		Permissible deviation in mm
From	to:	Tolerance (approx. $\pm 0.5\%$)
-	149	± 0.7
150	174	± 0.7
175	199	± 0.8
200	224	± 1.0
225	249	± 1.1
250	274	± 1.2
275	299	± 1.3

300	324	± 1.5
325	349	± 1.6
350	374	± 1.7
375	399	± 1.8
400	-	± 2.0

Calculation example:

Calculation of the permissible deviation in mm for Length L, Width W and Height H for -0.5% and +0.5% deviation, values here are rounded off to a whole 0.1.

Example:

- A nominal dimension of 400 mm can therefore lie in the range from 398.0 mm to 402.0 mm.
- A crate dimension of 400 mm has for -0.5% (-2.0 mm) = 398.0 mm undersize
- A crate dimension of 400 mm has for +0.5% (+2.0 mm) = 402.0 mm oversize

2.3 Divider geometry

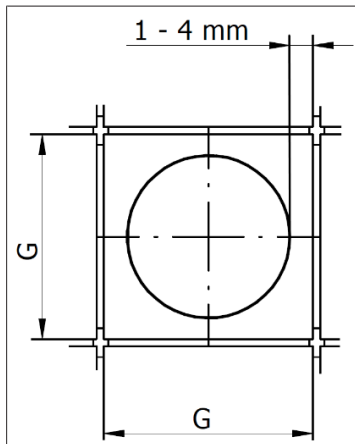

Fig. 17: Circumferential gap from container to divides

To ensure that the containers fit in the dividers, they must be designed so that the bottle diameter for the greatest tolerance has a circumferential gap of at least 1 mm to the dividers. To enable the containers to be removed from the dividers, this circumferential gap between the smallest dimension of the container and the dividers may not be larger than 4 mm. The largest container dimension is the still permissible tolerated oversize of the bottle; the smallest container dimension is the still permissible tolerated undersize of the container. The inner dimension of the dividers is the dimension marked with G in the adjacent illustration.

Example:

According to the Kronen container specification, a glass bottle with a nominal diameter of 70.5 mm has a tolerance of ± 1.4 mm. This then results in a smallest dimension of 69.1 mm and a largest dimension of 71.9 mm for the glass bottle. According to this, the inner dimension of the dividers must be between 73.9 mm and 77.1 mm.

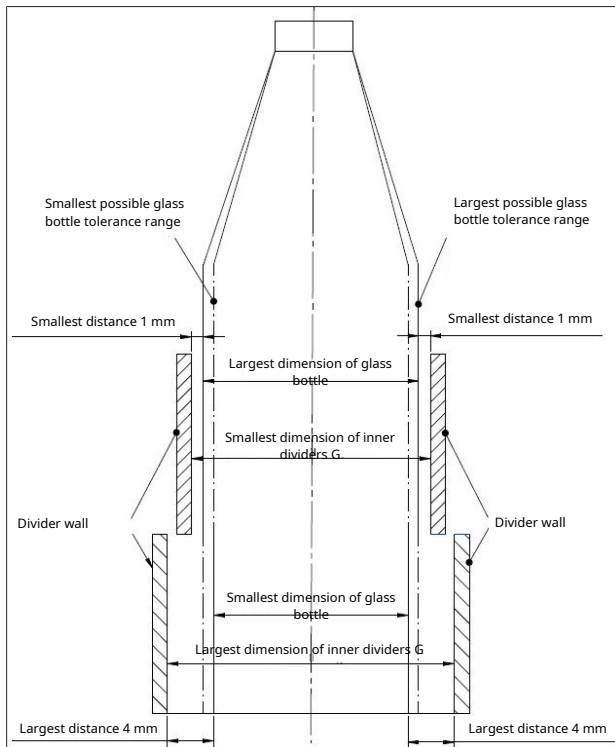

Fig. 18: Optimum largest and smallest distance from glass bottle to divider geometry.

The range of the inner dimension of the dividers is calculated as follows:

The smallest still permissible inner dimension of the dividers is calculated from the largest dimension of the glass bottle (71.9 mm) and the minimum distance of 1 mm on both sides.

$$73.9 \text{ mm} = 71.9 \text{ mm} + 2 \times 1 \text{ mm}$$

The largest still permissible inner dimension of the dividers is calculated from the smallest dimension of the glass bottle (69.1 mm) and the maximum distance of 4 mm on both sides.

$$77.1 \text{ mm} = 69.1 \text{ mm} + 2 \times 4 \text{ mm}$$

2.4 Permissible deformation

Beverage crates can deform during processing. These deformations of the crate are still permissible up to a certain dimension. However, here it must be observed that despite deformation of the dividers, the circumferential gap dimension between the tolerated largest and smallest dimensions of the container and the dividers in the range of 1 mm and 4 mm mentioned in the Chapter 2.3: Divider geometry [▶ 10] must be complied with.

A deformation of the outer contour is also permissible as long as the dimensions are within the tolerance range of the crate outer dimensions defined in the Chap. 2.2.2: Shape/geometry and dimensional accuracy [▶ 9] The specified tolerance range is therefore not only the manufacturing tolerance, but also includes the permissible deformations.

Due to the base, the lower area of a beverage crate has the greatest stiffness. The zone marked in the adjacent illustration visualises this area. The upper geometry of the crate is more subject to deformations.

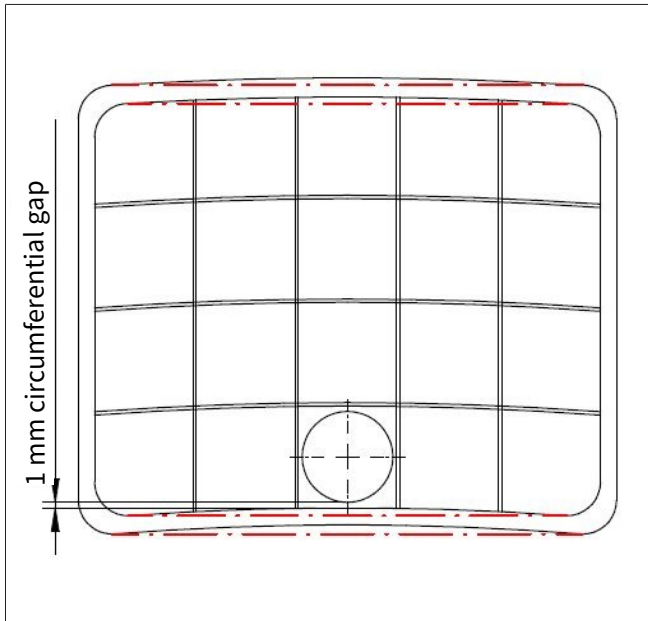

Fig. 19: With deformation, a circumferential gap of at least 1 mm is also required

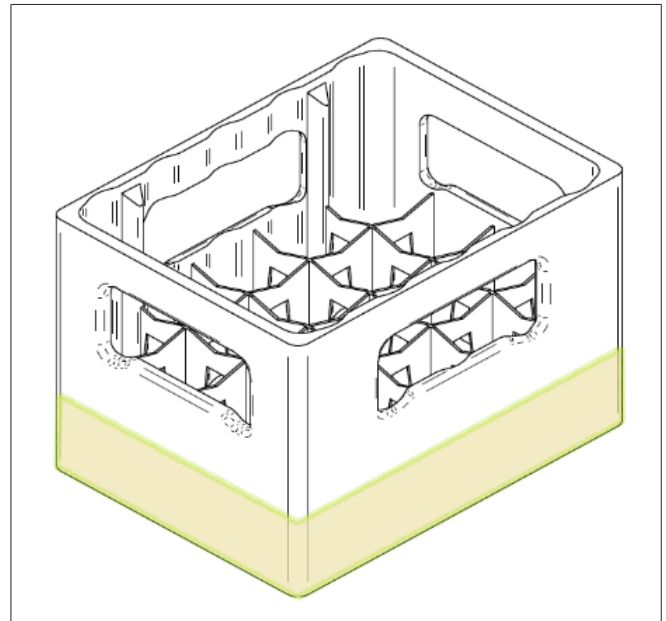

Fig. 20: The most stable area is located in the lower half of the crate

2.5 Handle geometry

The width of the opening b must be at least 90 mm and the height of the opening h must be at least 40 mm. The bar height of the handle t must not exceed a value of 50 mm. The background for this value is the carrying and handle comfort of the crate. The consistent size and position of the handle opening is decisive for the swinging process of the gripping hook. The dimensions (h , w and t) are relevant for the openings of the lengthwise and lateral side. In case of major deviations in the shape or the non-compliance with the minimum dimensions, Kronos AG must be consulted. Optimally, handle openings are provided on all four sides.

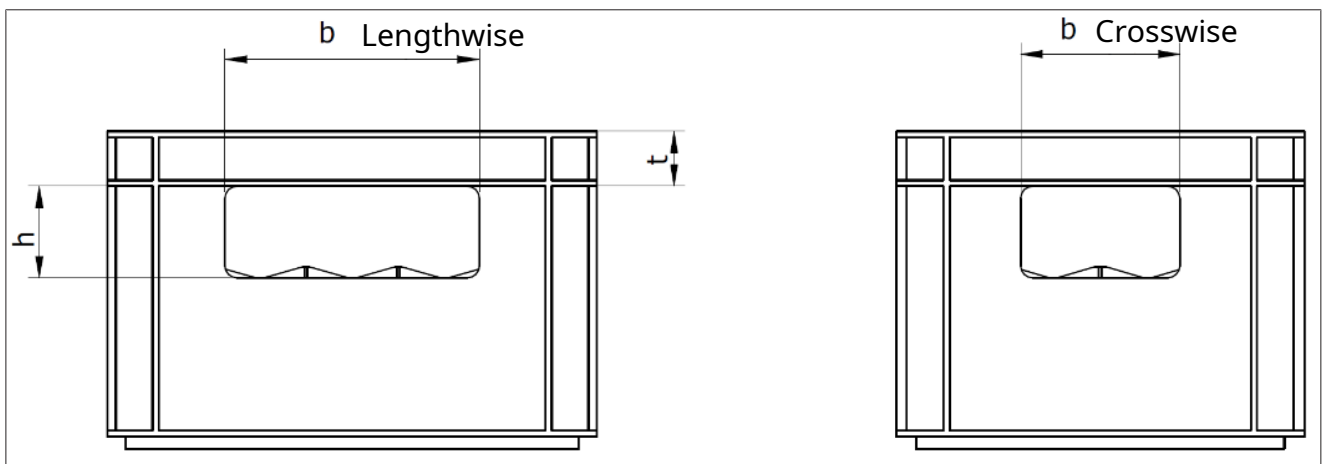

Fig. 21: Dimensioning of handle opening

- h = opening height
 $h_{\min} = 40 \text{ mm}$
- b = opening width
 $b_{\min} = 90 \text{ mm}$
- t = handle strip height
 $t_{\max} = 50 \text{ mm}$

Other geometries:

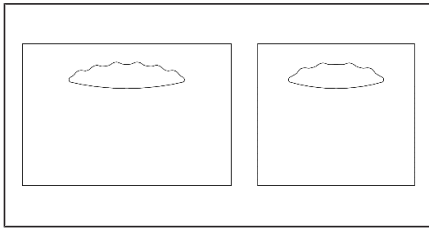

Fig. 22: Curved handle opening

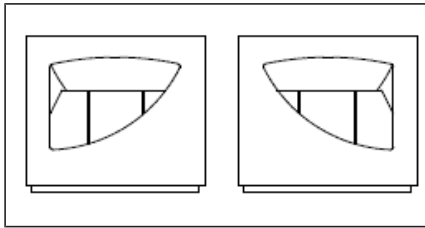

Fig. 23: Triangular handle opening

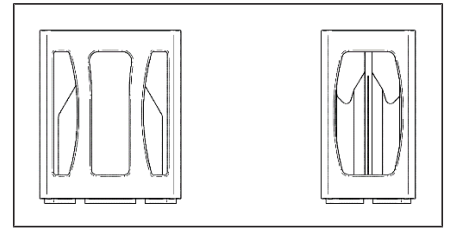

Fig. 24: Large-area handle opening



Fig. 25: Hook access in beverage crate (perspective view)



Fig. 26: Hook access in beverage crate (cross sectional view)

3 Geometric characteristics for beverage crates

If a customer plans to introduce new beverage crates, KRONES provides the following recommendations. However, these make no claim to completeness for ensuring handling in processing. In general, the requirements already mentioned above should be observed.

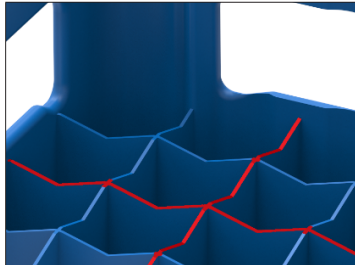

Fig. 27: Bars with higher connecting points

The bars of the dividers should be higher at the connecting points than in the centre of the bars. These so-called guide inclinations enable easier insertion of the container in the beverage crate. In addition, the bars should be so high that the containers do not touch each other in the crate.

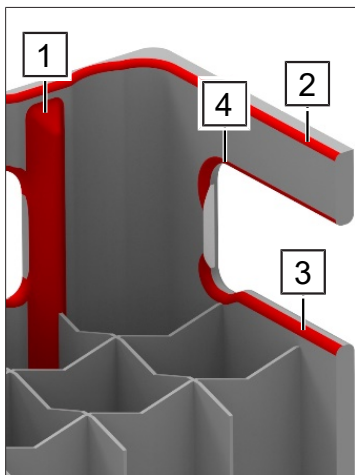

Fig. 28: Chamfering and filleting on crate geometry

Edge stiffening columns (1) and the upper inner edge of the crate edge (2) should be provided with chamfers and fillets to simplify the insertion of containers and to avoid bumping and locking errors. Locking errors are understood to be incorrect locking when stacking beverage crates. The filleting of the handle openings prevents bottles from jamming in the opening during the packing process (3). The filleting on the top side of the handle opening (4) prevents containers with an opened swing-stopper from getting caught and enables the end user to grasp better manually.

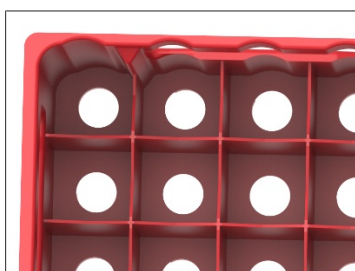
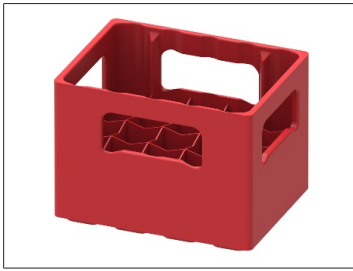

Fig. 29: Chamfering and filleting on crate geometry

Non-returnable PET bottles to be returned deform when the temperature difference between the air in the PET bottle and the ambient temperature is too great. These containers could jam in the pack due to their deformation. Here a cut-out can be provided on the underside of the crate. An additional machine enables these jammed containers to be ejected. If the customer already has corresponding experience with problems of this kind, the KRONES Design department should be contacted.

Geometric characteristics for beverage crates



The outer geometry of a double-walled crate should be cuboid with primarily flat side walls if possible. To detect the crate well with P.E. sensors, it is also practical if the beverage crate has wide surfaces at the corner edges.

Fig. 30: Optimum outer geometry of a beverage crate

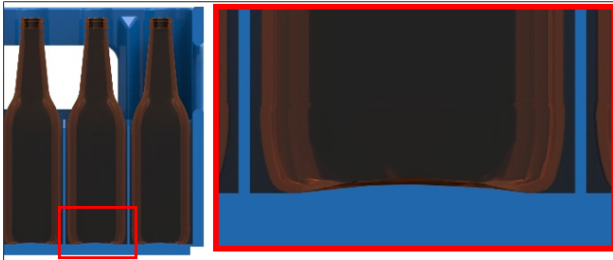

The curvature on the base of the container and that of the crate base should correspond to each other with regard to their shape. With a slightly convex curvature of the divider base, the container could centre itself in the dividers when vibrations occur.

Fig. 31: Curvature of divider and bottle base



Horizontal "ribs" on the corner areas of the beverage crate can enable a holding form fit when clamping several crates. Due to the not so high necessary clamping forces, the loads and elastic deformation of the beverage crates are reduced.

Fig. 32: Horizontal ribs on corner area

In addition, the crate should be designed symmetrically. This means that there should be no "front" or "rear". This especially applies to honeycombed dividers. As a result, the orientation of the pack can be ignored.

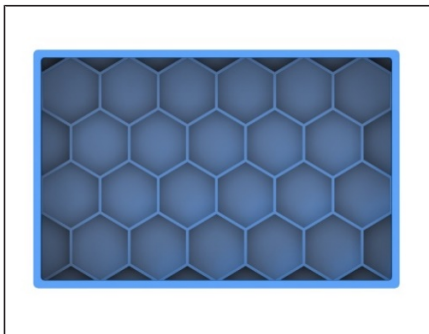

Fig. 33: Asymmetrical honeycomb dividers



Fig. 34:

4 Important aspects for avoiding/minimising additional expenditures or processing obstacles

Certain unfavourable contexts can endanger processing. This can result in possible additional expenditures.

In accordance with this, beverage crates can only be processed with additional work and costs or not at all when the following points apply. The beverage crates must be checked for these aspects from the outset to grant a release. In case of additional work, additional costs must be expected to result accordingly.

If the tolerances specified by the customer or indicated on the drawing are greater than the tolerances stated in this specification, the customer must inform Sales. In this case, corresponding tolerance adjustments to the assemblies of the machines can usually be carried out with additional expenditures in order to ensure processing.

4.1 Classification of quality levels and related performance losses

The delivered state of beverage crates and the containers they contain can be classified in 3 quality levels. The adjacent images are intended to illustrate the division of the levels.

Quality level 1:

The beverage crates and the containers they contain are virtually new. They are neither deformed nor damaged. There are no bulky goods in the pack. Quality level 1 can be processed very well.



Fig. 35: Like-new crate without damage



Fig. 36: Like-new pack without damage



Fig. 37: Like-new crate without damage

Quality level 2:

The dividers and the crate edges of the beverage crates are slightly damaged and deformed. There are no bulky goods in the pack.

Quality level 2 can be processed with additional work and performance losses.

Important aspects for avoiding/minimising additional expenditures or processing obstacles



Fig. 38: Slightly damaged pack



Fig. 39: Slightly damaged crate base

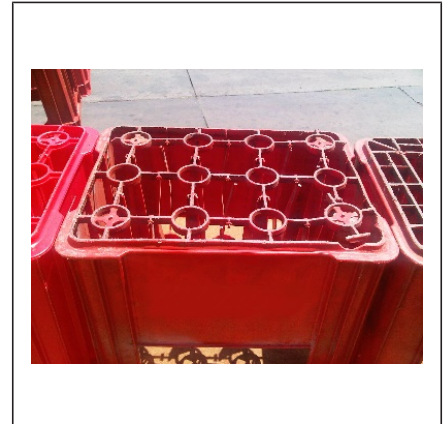

Fig. 40: Slightly chipped crate base

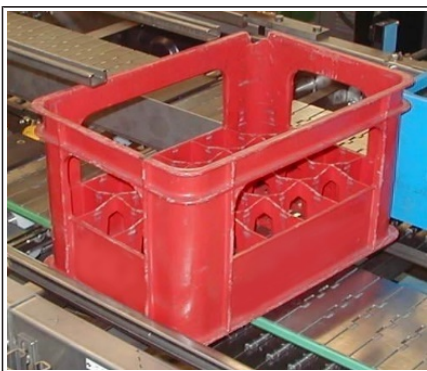

Fig. 41: Damaged crate edge



Fig. 42: Slightly pressed-in crate wall

Quality level 3:

The beverage crates and the crate bases are broken and partially broken out and heavily deformed. The bottles they contain are broken, heavily deformed and are partially upside down in the beverage crate. Quality level 3 cannot be processed by machine.



Fig. 43: Damaged and incorrectly oriented PET bottles



Fig. 44: Chipped crate base



Fig. 45: Pressed-in crate wall



Fig. 46: Foreign objects in the crate



Fig. 47: Broken-out dividers



Fig. 48: Foreign objects and incorrectly oriented glass bottles in crate

The possible influence of the various quality levels on the efficiency of the machines is explained in the following table. The data are empirical values from customers and therefore without guarantee of absolute accuracy.

Pack quality	Degree of mixing of quality levels			Efficiency of returnable packers and palletisers
	1	2	3	
Optimum	100.0%	0.0%	0.0%	Standard efficiency, e.g. 98%
Good	90.0%	7.5%	2.5%	-5%
Moderate	85.0%	10.0%	5.0%	-10%
Bad	70.0%	20.0%	10.0%	-15%

If foreign bottles are contained in the empty containers before packaging the containers or a large quantity of broken glass due to poor container quality, there may be further losses of efficiency.

4.2 Geometric, material-dependent conditions

The beverage crates must be easily stackable. If this is not the case due to deformations or an inaccessible (too narrow/too wide) locking geometry, malfunctions and as a result also performance losses must be expected.

This also applies with regard to the container height. There must be a clearance between the cap of the container and the base of the next laid-on crate to ensure proper stackability. With stacked beverage crates, no other crates may be pulled along below when lifting the top crates. This would be the so-called negative "Lego effect".

Important aspects for avoiding/minimising additional expenditures or processing obstacles

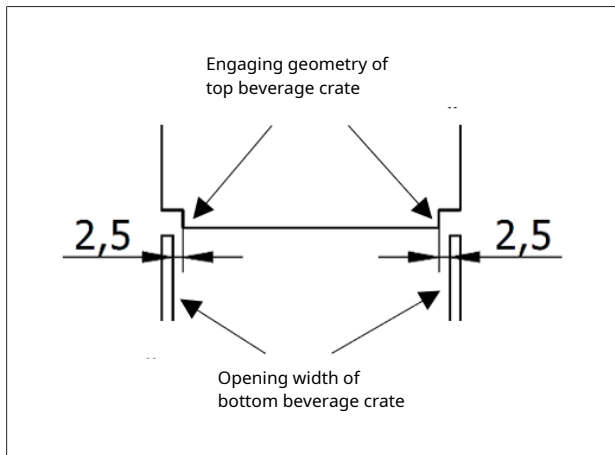

Fig. 49: Representation of the stacking clearance of 5 mm

The stacking clearance is the difference of the engaging geometry of the upper beverage crate and the opening distance of the lower beverage crate. This means the top crate can shift horizontally in the bottom crate by the value of the stacking distance. A lateral clearance of at least 5 mm is specified here. The stacking clearance of 5 mm, i.e. 2.5 mm per side, is illustrated in the adjacent illustration.

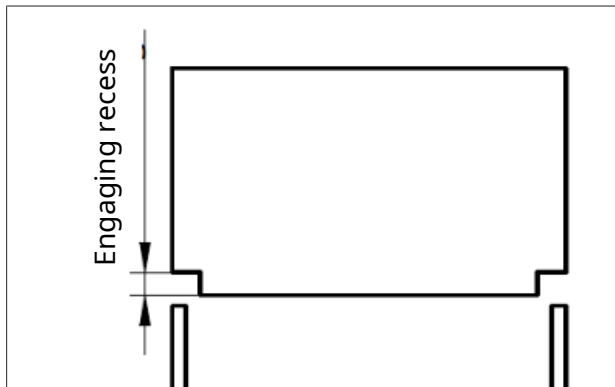

Fig. 50: Representation of the crate engaging recess in a side view

The optimum stacking clearance is given when crates are placed loosely locking on each other vertically and can be lifted off again without the "Lego effect". The locking recess, also known as the engaging height, should optimally be at least 8 mm. Beverage crates with the same and different manufacturer batches must comply with this stacking clearance and the stackability must be ensured.

Important aspects for avoiding/minimising additional expenditures or processing obstacles

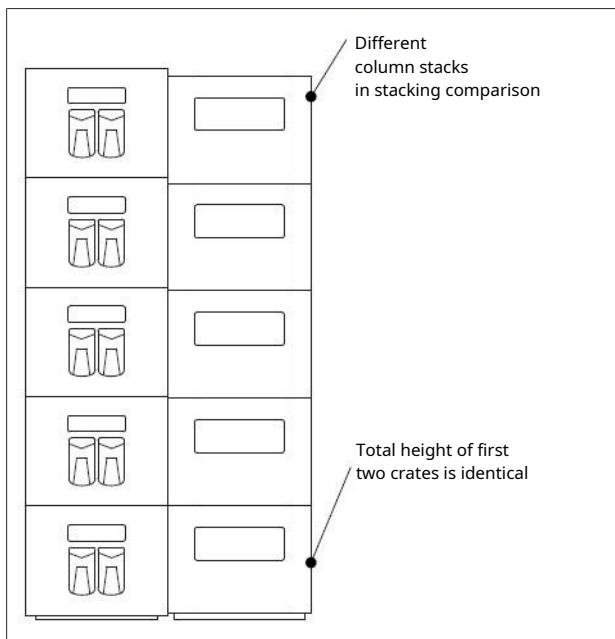

Fig. 51: On left low engaging recess for stack
On right high engaging recess for stack

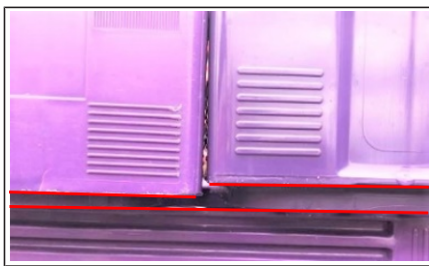

Fig. 52: On left low engaging recess
On right high engaging recess

Crates with the same total height, but with a different engaging recess height are optimally not to be processed together. With stacked crates, only the outer wall heights are added together. With the processing of two crate types with greatly differing engaging recesses result when stacking the crates to different column heights which differ on the top layer most clearly. This can result in problems when stacking or lifting off. For example, crates of the bottom layer standing deeper can also be torn upward when lifting off layers with different stacking heights by means of the clamping function, which can reduce the efficiency of the machine.

The low side crates filled with containers are an exception here. The top crate stands with its base on the cap of the container of the bottom crate during stacking. As a result, the "Lego effect" cannot occur with bottles inserted.

The engaging inclination should run conically downward toward the centre, as shown in the bottom right illustration. This simplifies stacking engagement. With older, difficult to process beverage crates, the inclination can point in the other direction. This means when viewed from top to bottom, the engaging inclination is inclined in an unfavourable way to the crate edge angled downward to the outside, as shown in the bottom left illustration. However, this kind of engagement requires a more exact positioning and an additional vertical force. This type of engaging inclination is to be avoided, as it makes stacking the crates considerably more difficult. In addition, when lifting off the top beverage crates in layers, the crates located below are frequently also pulled off.

Important aspects for avoiding/minimising additional expenditures or processing obstacles



Fig. 53: Older crate model with unfavourable engaging geometry

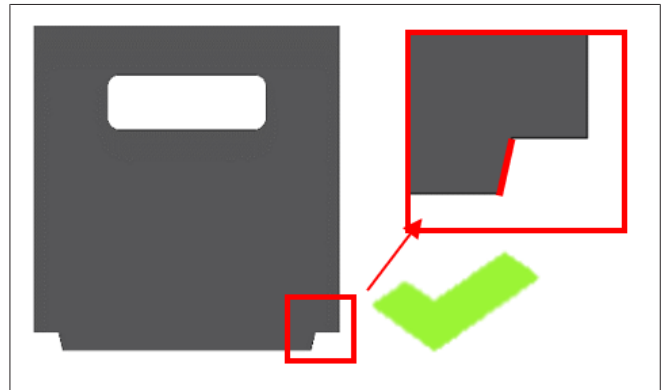

Fig. 54: Beverage crate with preferable engaging geometry

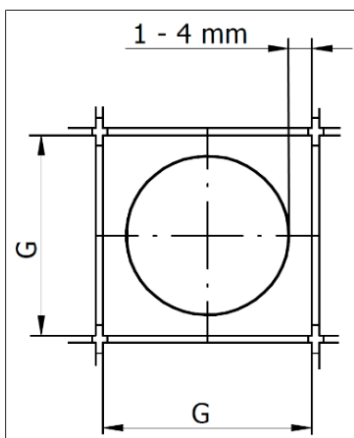

Fig. 55: Circumferential gap from container to dividers

The gap between containers and dividers must match the range of 1 mm to 4 mm explained in the chapter 2.3: Divider geometry [▶ 10]. Failure to comply with this tolerance can lead to limited performance and processability, and even to the inability to process.



Fig. 56: Beverage crate with excessively large corner window

Excessively large side windows can result in containers falling out of the crate or jamming in case of vibrations. This is especially relevant for open corner windows.

Important aspects for avoiding/minimising additional expenditures or processing obstacles

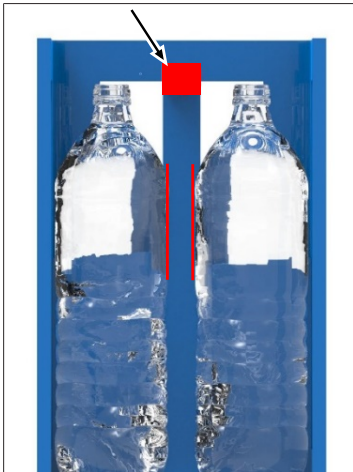

Fig. 57: Here the centre crate handle covers the outer contours of the PET bottle cross-sectional area. Crate entry opening is smaller than PET bottle

When packing and unpacking containers in the beverage crates by machine, at least the entire cross section of the bottle to be packed should be available. Otherwise, the containers collide with the protruding parts of the beverage crate due to overlapping.

If beverage bottles cannot be inserted or pulled out straight from above due to undercuts at the handles etc., they cannot be processed at all or only with additional work. The area marked in red in the adjacent illustration is intended to show an example of the undercutting of the container to the handle.



Fig. 58: Beverage crates with narrowing centre handle



Fig. 59: Glass bottle not completely standing on crate base

There must be no containers in the beverage crate which are not standing completely on the crate base. This occurs when the container in the crate is too small for the dividers and therefore usually stands tipped. This is shown in the adjacent illustration.

Important aspects for avoiding/minimising additional expenditures or processing obstacles

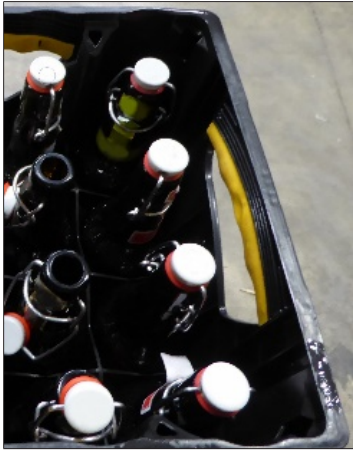

Fig. 60: Crate with soft-touch handle

Soft-touch handles are used for better handleability when carrying a beverage crate manually. The handle strips should not be too soft here in order to ensure a consistent service life of the crate and handle strip material. The Krones Design department should be informed when very soft handle strip material is used.

When transporting crates on conveyors, it should always be ensured that the pack optimally retains its transport orientation. So that no twisting or tipping over of crates occurs during acceleration or deceleration on the pack conveyor, the crates should have a length that corresponds to the direction of travel.

Therefore, beverage crates with a length under 300 mm to the direction of travel of the pack conveyor should be checked in the specialist technical department for stability.

If the beverage crates to be processed have an extremely white colour or a light-coloured imprint or light-coloured logos, there is a danger that the dark-coloured fastening assemblies will rub off on them. If the customer already knows from experience that crate surfaces are susceptible to discolouration, please make a note of this in the contract documents. Then special rubber mixtures can be used to counteract the discolouration.

The inner side of the handle openings must be freely accessible for manual transport. For pin-partitioned crates with multipacks, the handle openings may be covered. However, it must be ensured for processing with gripper heads that the gripper hooks can pivot into the handle strips. However, if the handle strip is installed, processing can only be carried out with greater effort.



Fig. 61: Unfavourable arrangement of multipacks in crate

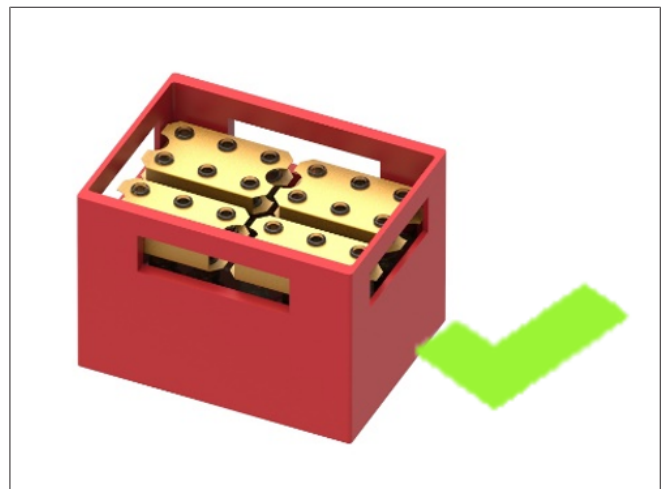
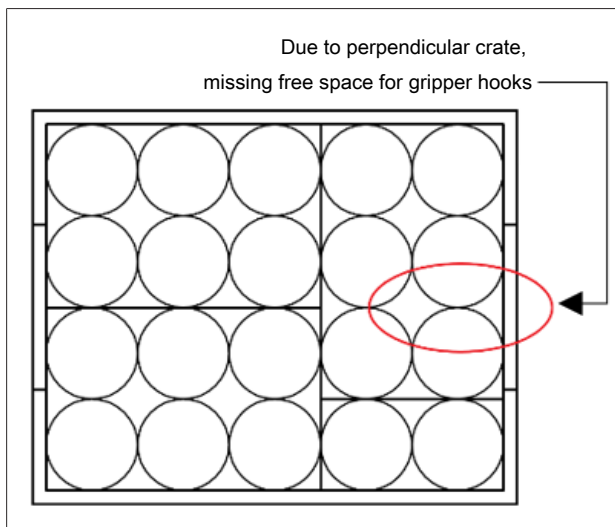

Fig. 62: Favourable arrangement of multipacks in crate

Important aspects for avoiding/minimising additional expenditures or processing obstacles



The adjacent illustration shows an unfavourable combination.

Fig. 63: Beverage crate and multipacks without sufficient free space



With single-walled beverage crates with reinforcement ribs on the outer side, it is possible in the crate line-up that these ribs are pushed into each other, as shown in the adjacent illustration. If the customer already has corresponding experience with this situation, this must be pointed out to Krones. This enables measures to be taken to prevent a loss of performance. However, this only occurs when there is no vertical bar on the beverage crate, as this prevents the crates from being pushed into each other.

Fig. 64: Reinforcement ribs of two crates pushed into each other

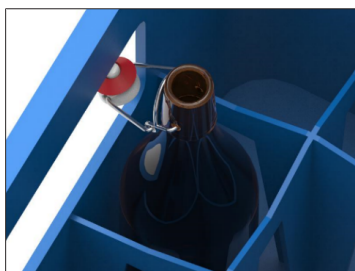

The combination of swing-stoppers and crates can lead to complications if the opened swing-stopper gets caught on the opening of the beverage crate. If this is familiar to the customer from experience with the sample product, a technical clarification would be required to take this into account when designing the machines.

Fig. 65: Swing-stopper caught on handle opening

Beverage crates must be pressure resistant to be clamped and raised with jaw grippers. If this pressure resistance is not provided, the crate yields when clamped, possibly preventing it from being raised.

4.3 Delivery and condition

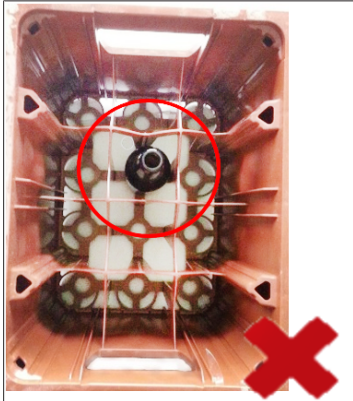

Fig. 66: Glass bottle in beverage crate too small

To ensure processing without performance and processing reductions in the packing and palletising area, the following points must be observed for the delivery of beverage crates.

The diameter of the containers and the size of the dividers must match within a certain range. In the adjacent illustration the beverage crate contains a glass bottle with a diameter which is too small.



Fig. 67: Broken-out beverage crate base

The crate edge and the crate base must not be broken, as start-up is not possible or can only be carried out under difficult conditions with broken material.



Fig. 68: Beverage crate with incorrectly oriented containers

The delivered bottle crate must be free of bulky goods. Bulky goods can, for example, be broken containers or the remains of pallets.

There must not be heavily deformed or damaged containers in the crate. In addition, the containers must be standing in the crate dividers with their bases facing downward. If the customer already has experience with fallen-over containers in the crate, the Krones Design department must be contacted. As soon as there are fallen-over containers in the beverage crate, the crate cannot be processed with standard modules. Special machines are required here within a limited scope.



Fig. 69: Beverage crate with foreign bottles

There should not be any foreign bottles in the pack. Foreign bottles are containers that have different shapes, diameters or heights than the samples provided. Processing is seriously endangered by foreign bottles and may no longer be ensured under certain circumstances. Reduced performance must be expected.

If there are iced-up or show-covered beverage crate stacks on the pallets on delivery for depalletising, they cannot be easily processed. In this case, Krones must be informed early.

Crates with a smooth outer wall can be extremely slippery when wet. This effect is intensified further by residues of caustic solution and cleaning agent from the crate washer. The design work for the jaw grippers is considerably increased for wet and slippery packs. If the customer can make corresponding

Important aspects for avoiding/minimising additional expenditures or processing obstacles

statements based on experience, please make a note of this in the contract documents to inform the Design department of KRONES AG so that this can be taken into account when designing the machines.



Fig. 70: Beverage crate with drinking straw in glass bottle

If drinking straws protrude far out of the beverage bottles due to the sugar content, they can catch on the beverage crates one level higher or become stuck on there. Other possible consequences are pulled-along containers and malfunctions in height scanning of the lift-off device. This results in approach faults during processing. This primarily applies to containers in low-side crates, as these are considerably lower than ordinary containers. The length of the straws is between 20 mm and 25 mm. If the customer knows from experience that there are drinking straws in the containers and they protrude out of the containers, please pass on this information to Sales at Krones AG.

Strapping band, also called straps, are used to achieve greater stability of stacked beverage crates. Here often only the top layer in the horizontal direction is bound together. If the straps are not completely removed before depalletising, one possible consequence is reduced performance due to frequent malfunctions in the processing machine.

It is possible during depalletising that not only empty container crates, but also full container crates are processed, e.g. to route expired products back into the disposal circuit. An independent selection program in the controller is required here. Therefore, the customer must notify KRONES Sales of this so that a control program especially directed at full load can be set up here. Then the acceleration can be minimised with regard to full load.

The spaces between the bottle necks in the crate must be completely freely accessible during processing. Sunshields or other advertising inserts which cover the bottle necks must be removed from the crate either manually by the customer or by machine before unpacking the containers. Additional work is required for loading crates with sunshields, etc. and KRONES Sales must be informed of this at an early stage.

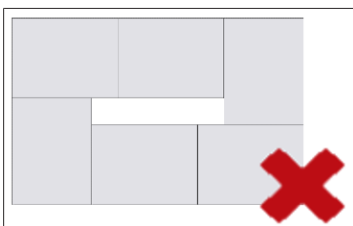

Fig. 71: Layer pattern with space in the centre

Layer patterns with free space in the centre of the layer can only be unloaded with a jaw gripper under special conditions. As the layer weight increases, the chances for success when using a jam gripper system drop. Layer patterns similar to the adjacent illustration should be avoided.

Dividable beverage crates must be fed to the depalletiser in the assembled state. The beverage crate halves must not be stacked individually on the pallet.

There may only be beverage crates on the pallet which have the same geometry and size as the equipment specifications. With other delivered geometric shapes, e.g. a different shape of the handle openings, performance reductions, such as long downtimes, non-processing or major conversion work, must be expected. If mixed product is already familiar from experience, please pass on this information to our Sales department.

Pallets:

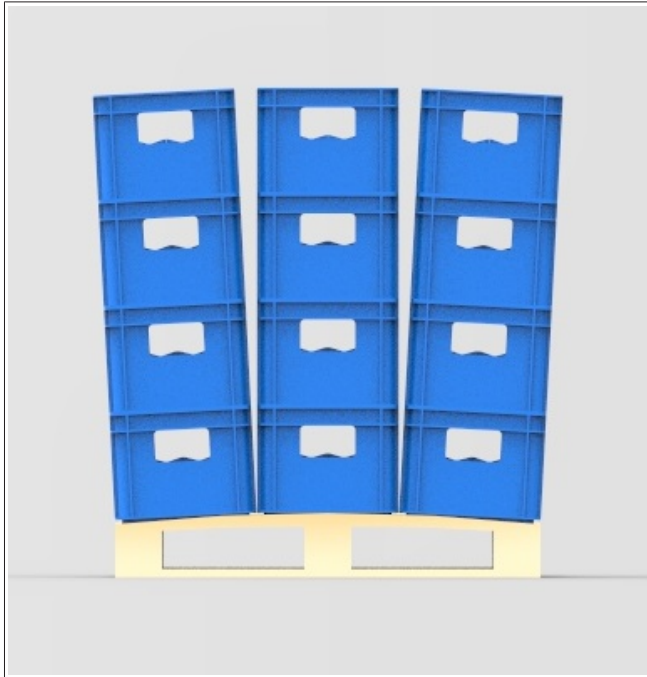

Fig. 72: "Bulging" pallet, arched upward with increasing stacking gap: Critical for processing



Fig. 73: Pallet lowered downward: Conditionally critical as long as the crates still lock

Pallets must not be arched or damaged on their standing surface. The above illustrations show the two possible basic types of "bulging" pallets. The top surface of the pallet must be flat to allow optimal processing. With column stacking, a pallet arched upward has the effect that the individual columns do not stand vertical to each other and drift apart at the top. Even a small bulge can lead to ever greater distances in columns growing higher. Then processing may not be possible or additional work will result. The more crates are stacked on each other, the greater the deviation from the nominal position becomes.

For information on pallet conditions, see the official website of EPAL – The pallet system. The product data sheet there specifies the permissible deviations and describes the types of damage that have to be repaired so that they can be exchanged.

The following pallet damage has to be repaired:

- If a board is missing
- A bottom or top board is splintered in such a way that more than one nail or screw shank is visible.
- If a block is missing or split in such a way that more than one nail shank is visible.
- A board is broken transversally or diagonally.
- If more than two bottom or top boards are splintered in such a way that more than one nail shank is visible.

Important aspects for avoiding/minimising additional expenditures or processing obstacles

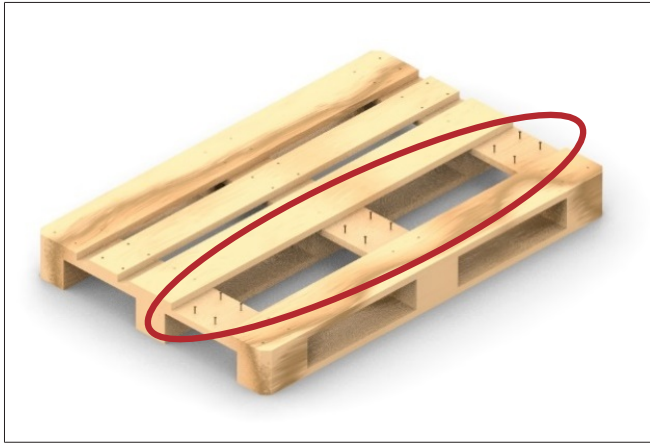

Fig. 74: If a board is missing

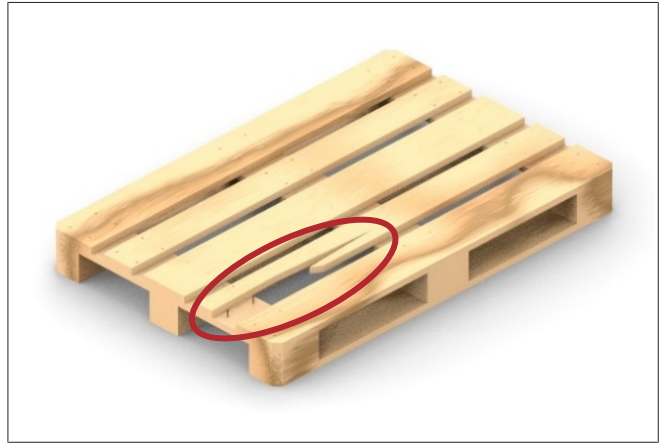

Fig. 75: If a bottom or top board is splintered in such a way that more than one nail or screw shank is visible.

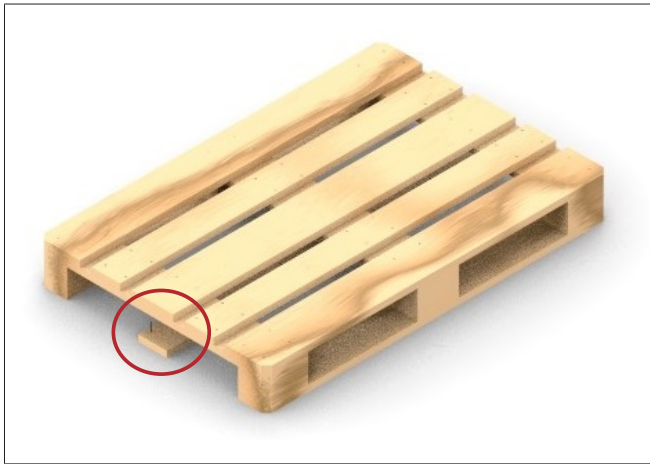

Fig. 76: If a block is missing or split in such a way that more than one nail shank is visible.

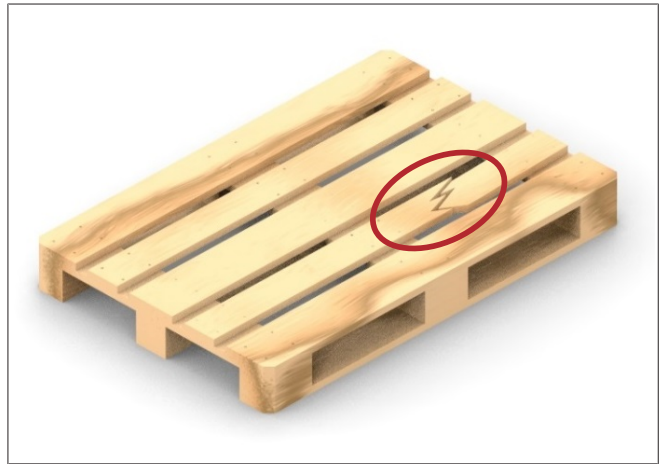

Fig. 77: A board is broken transversally or diagonally.

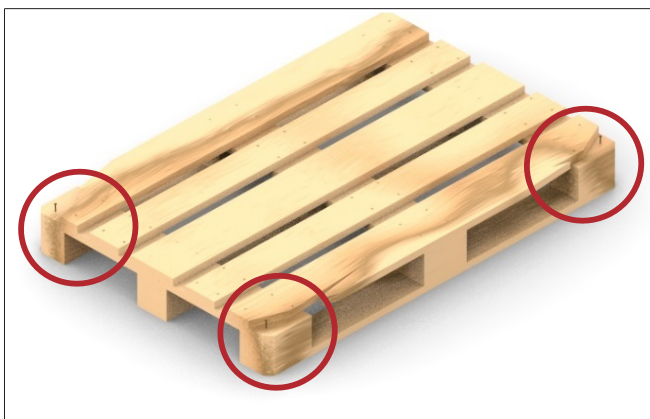

Fig. 78: If more than two bottom or top boards are splintered in such a way that more than one nail shank is visible.

Additional exclusion characteristics:

- If the load capacity is no longer ensured
- If loads are contaminated by a dirty pallet



Important aspects for avoiding/minimising additional expenditures or processing obstacles

- If there is heavy splintering on several blocks
- If impermissible components are used for repairs

5 Beverage crates with multipacks

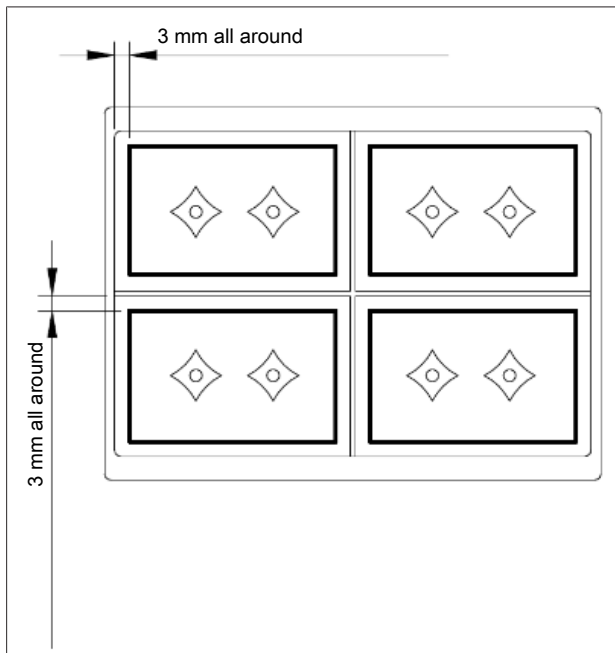

Fig. 79: Circumferential gap from beverage crate to multipack

With multipacks, there must be a circumferential gap between the packs and the beverage crate. This is necessary to ensure insertion of the packs and in order not to damage them. In the process, so-called pins are provided in the crates to guide the packs and to ensure positioning.

To process the packs, a circumferential gap must be maintained between the packs and the beverage crate. This gap width applies circumferentially for each pack. The gap should be 3 mm. Compliance with the gap for special shapes, such as crates with integrated handles, must also be observed.



Fig. 80: Beverage crate with multipacks and swivelled-in gripping hook

When the multipacks are standing in the beverage crate, there must be a sufficiently large space for the handle opening between the packs. The space must also be large enough that a gripping hook can swivel in there mechanically. This enables the use of a commercial gripper system. The combination of beverage crates and the multipacks in them should therefore be checked by the customer.

In addition, there should be no additional divider bars (red lines) for individual containers in pin-partitioned crates, as these additional bars damage the multipacks when they are inserted. The following illustrations show a pin-partitioned crate with and without additional individual dividers.

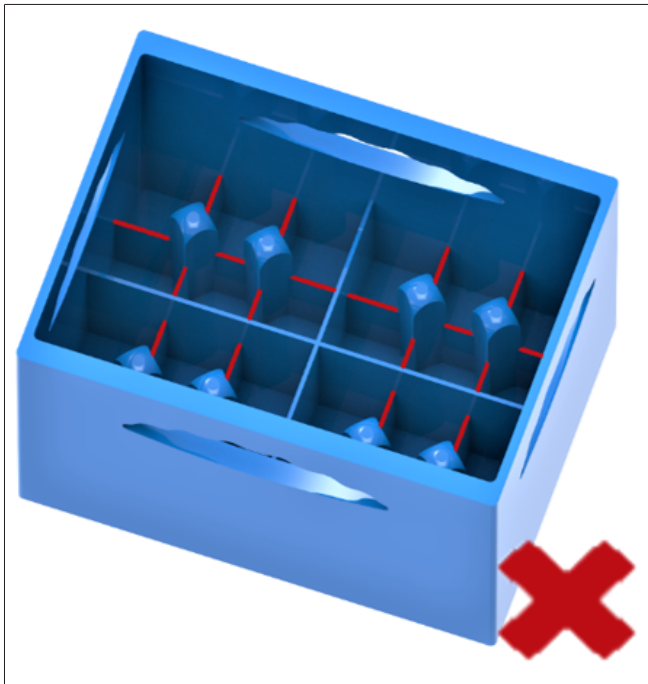

Fig. 81: Pin-partitioned crate with divider bars for individual containers



Fig. 82: Pin-partitioned crate without divider bars for individual containers

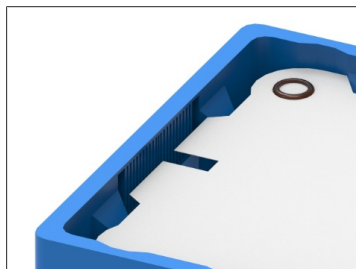

Fig. 83: Sunshield with face slit

When using sunshields, slits can be inserted to enable the use of a common positive-fit hook gripper system. The adjacent illustration shows a pack with a centred cut-outs on the edge of the sunshield. In this version, the crate can be processed with gripper hooks in spite of a sunshield.

If baskets are used, they should at best be arranged as shown in the right-hand illustration. This enables easy use of gripper hooks. The gripper hooks should have sufficient space laterally when moving into the gripping opening.

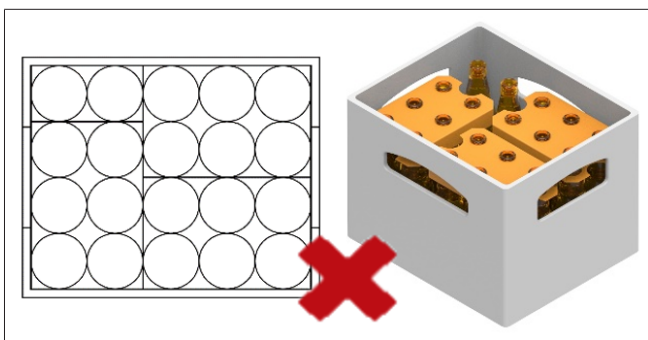

Fig. 84: Unfavourable basket arrangement in beverage crate

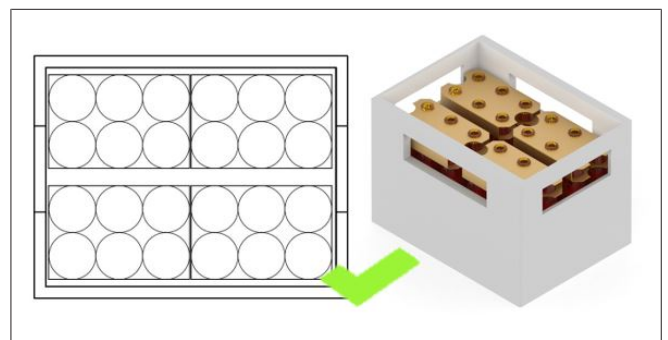

Fig. 85: Favourable basket arrangement in beverage crate

6 Stackability and palletising

6.1 Stackability

A fundamental distinction is made between column and group stacking. With column stacking, the beverage crates stand exactly over each other. The individual columns are not connected. The layers always have the same orientation. In contrast, with group stacking the orientation of the layers to each other differs. Every second layer is usually turned by 180°. This provides for better stability of the crate stack on the pallet.

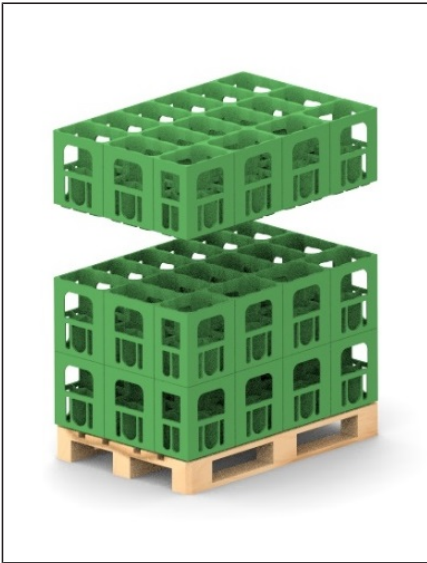

Fig. 86: Column stacking on pallet



Fig. 87: 180° group stacking on pallet

Not all packs that can be stacked in columns are also suitable for group stacking. On the other hand, beverage crates that can be stacked in groups can also be stacked in a column. The reason for this is the engaging geometry of the crate base. Only column stacking can be realised with an ordinary base geometry. Group stacking is also possible with so-called "nest arrangements" on the base of the beverage crate.

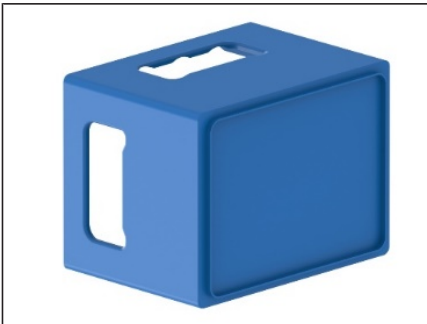

Fig. 88: Ordinary engaging geometry for column stacking

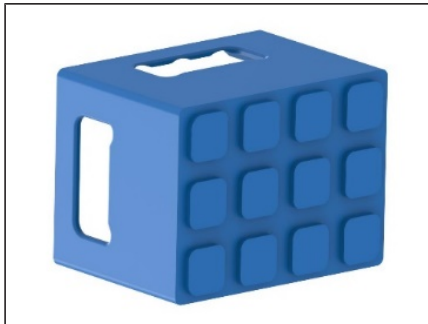

Fig. 89: Nest distribution for group stacking

6.2 Palletising

Pallets are used to transport a large number of beverage crates simply and efficiently. They simplify transport and storage of packs. They can be made of wood, plastic or cardboard. The most frequently used pallet sizes are listed in the table below.

Euro-pallet	1200 mm x 800 mm
Brewery pallet	1100 mm x 1070 mm
Industrial pallet	1200 mm x 1000 mm
Düsseldorf pallet	800 mm x 600 mm
Chep quarter-pallet	600 mm x 400 mm
Pallets common in America and China	48 x 40 inch equals 1,219.2 mm x 1,016 mm
Popular in Asia	1,100 mm x 1,100 mm or 1,140 mm x 1,140 mm

7 Summary

In summary, it can be said that the crate quality and tolerance differences affect the efficiency of the packing and palletizing machines. Therefore, the machine may not be able to start to operate without trouble if packs of poor quality are used.

In addition, it is important that the crates do not differ too greatly in their geometry and size within a layer/stack. The condition of the pallets also affects palletising. If these influencing factors are not observed, failures due to malfunctions can occur which affect the efficiency of the machine.

This specification is intended to support the exchange of information between the customer and the KRONES machine designer on the special features of the customer crate. As a result, important knowledge on the special features of the crate can be determined and conveyed at an early stage.

Glossary

Commissioning sample crate

Commissioning sample crates are required for internal commissioning in large quantities.

Depalletising:

Depalletising is the lifting of individual pack layers off a pallet stack.

Empty container crate

Empty crates are crates filled with empty containers.

Empty frame

Empty frames are crates without containers.

Full container crates

Full container crates are crates filled with full containers.

Hand sample crate

Hand sample crates are necessary in individual quantities for designing the machine.

Packing

Packing is the inserting of filled and capped containers in the pack.

Palletising:

Palletising is the stacking of pack layers on each other on the pallet.

Sample crate

Sample crates are a superordinate term for hand samples and commissioning samples.

Unpacking

Unpacking is the lifting of containers out of the crate.