



# Specification

KRONES cardboard packaging specifications

## Table of contents

<b>1</b>	<b>General information</b>	<b>5</b>
1.1	Basic information	5
1.2	Delivery and storage of paper and cartons	5
<b>2</b>	<b>Corrugated cardboard</b>	<b>7</b>
2.1	General information	7
2.2	Requirements for corrugated cardboard	7
2.3	Usable materials	7
2.3.1	C flute	8
2.3.2	B flute	8
2.3.3	E flute	8
2.3.4	E/B flute	9
2.3.5	Examples of corrugated cardboard packaging	9
2.4	Bending rigidity	10
2.5	Types of cut-outs	11
2.5.1	Variants of the cut-outs and workability on the machines	11
2.5.2	Orthogonal cut-outs	12
2.6	General tolerances	12
2.6.1	Measurement requirements	12
2.6.2	Tolerances for creasing and cutting dimensions	13
2.6.3	Tolerances for maximum deflection	13
2.6.4	Gluing the flute	13
2.7	Printing on cardboard containers	13
2.8	Carrying strap – wrap-around carton	14
2.8.1	Glued carrying strap with counter-tab	14
2.8.2	Integrated carrying strap by cut-out	15
2.8.3	Plastic carrying strap inserted into recess	15
<b>3</b>	<b>Solid board</b>	<b>18</b>
3.1	Delivery and storage of pre-glued blanks	18
3.1.1	Outer packaging	18
3.2	Requirements for solid board	19
3.3	Examples of solid board packaging	19
3.4	Bending rigidity	20
3.5	Tolerances	21
3.5.1	Measurement requirements	21
3.5.2	Tolerances for creasing and cutting dimensions and maximum deflection	21
<b>4</b>	<b>Cardboard specification</b>	<b>22</b>
4.1	Folding and bending properties	22
4.1.1	Folding properties	22

4.1.2	Bending properties	22
4.1.3	Correlation between carton weight and container weight	23
4.2	Wrap-around cartons	23
4.2.1	Erecting process of a wrap-around carton (Variopac)	24
4.2.2	Tolerances with regard to wrap-around cartons	24
4.2.3	Difference between a carton with cover flaps and a wrap-around carton	25
4.2.4	Proposal drawing of a corrugated cardboard wrap-around carton	26
4.2.5	Proposal drawing of a solid board wrap-around carton	28
4.3	Cartons with cover flaps / American boxes	30
4.3.1	Proposal drawing of a carton with cover flaps (Varioline)	31
4.4	Proposed drawing of tray (Varioline)	33
4.5	Proposal drawing of a tray (Variopac)	34
4.6	Proposed drawing of Over-Top-Open (OTO)	34
4.7	U-pad processing	35
<b>5</b>	<b>Basket carrier</b>	<b>36</b>
5.1	Field of application	36
5.2	Material specification	37
5.3	Dimensional accuracy and processing	37
5.3.1	Distances	41
5.4	Delivery and storage	41
5.5	Storage	42
<b>6</b>	<b>Specification of dividers</b>	<b>44</b>
6.1	Palletising and storage	44
6.2	Usable materials	44
6.2.1	Examples of corrugated board and solid board dividers	45
6.3	Erecting process	45
6.4	Requirements for a divider	46
6.4.1	Tolerances	49
6.4.2	Distances	49
<b>7</b>	<b>Cardboard clips for cans</b>	<b>51</b>
7.1	Basic shapes for beverage cans	51
7.2	Specifications	52
7.2.1	Basic dimensions clip	52
7.2.2	Specifications for Basic Dimensions	52
7.2.3	Pick-up surfaces	53
7.2.4	Handle holes	56
7.2.5	Permissible press-on forces - Varioline	56
7.2.6	Permissible press-on forces - Variopac	57
7.3	Recommendations for carton design	57
<b>8</b>	<b>Cardboard clips for bottles</b>	<b>58</b>
8.1	Varioline	58



8.1.1	Design of the cut-outs	58
8.1.2	Pick-up surfaces	60
8.1.3	Tilt and stacking height difference	62
8.1.4	Permissible forces when removing and pressing on for 4 and 6 -packs	63
8.2	Variopac	65
8.2.1	Specifications for single-piece packaging	65
8.2.2	Specifications for two-piece packaging	66
8.2.3	Pick-up surfaces	67
8.2.4	Permissible press-on forces	68
8.2.5	Magazines	69
<b>9</b>	<b>Processing criteria</b>	<b>70</b>
9.1	Suitability of the containers	70
9.2	Requirements for inserting	71
9.2.1	Varioline	71
9.2.2	Variopac	73
9.3	Formation	74
9.4	Divider dimensions	74

# 1 General information

## 1.1 Basic information

This specification contains a broad range of packaging options. These possible combinations of material and material characteristics require a release by KRONES AG in all cases.

With standard equipment, in terms of packaging, customer materials that are already available can be checked and released for start-up by KRONES. If the customer is not yet in possession of the packaging materials, KRONES AG issues recommendations (proposals for the specific pack). These recommendations must be confirmed by the customer. The material drawings prepared by KRONES apply.

Following successful customer acceptance under production conditions on site (refer to the specifications for acceptance conditions), the packaging material used is logged, countersigned by both parties and thereby defined as a standard.

In the event of subsequent changes to the material and packaging, it is the customer's responsibility to inform KRONES AG of the matter and to obtain a release.

KRONES AG reserves the right to perform tests under conditions closely simulating production if changes are made to material or packaging by the customer.

The test materials required for this purpose must be provided by the customer. The scopes used for this test are agreed in advance with KRONES AG and could comprise the following, for example:

One shift (one day of approx. 8 hours) + sufficient packaging material.

Test results are recorded and given to the customer. Manual samples and/or finished packs are provided for examination. If the results reveal no defects for the customer, they are recorded in writing, signed by the customer and KRONES AG and defined as a new standard for packaging material for the associated packer.

If the tests show that the defects which are the subject of the customer's complaint are caused not by the design of the machine, but rather by the material, which is outside of KRONES specifications, KRONES reserves the right to bill the customer for costs incurred at standard market rates.

## 1.2 Delivery and storage of paper and cartons

Properties	Requirements
Storage at the machine	24 - 48 hours before processing
Optimum temperature range	15 - 20 °C
Storage of partially used/cut materials and remainders	Carefully packed and stored
General storage environment	No direct sunlight and not close to heaters, no storage in humid conditions
Storage duration	Max. 9 months
Transport	With top board; bottom and top board must be strapped; unfinished pallets must be covered by a top board (see figure below).

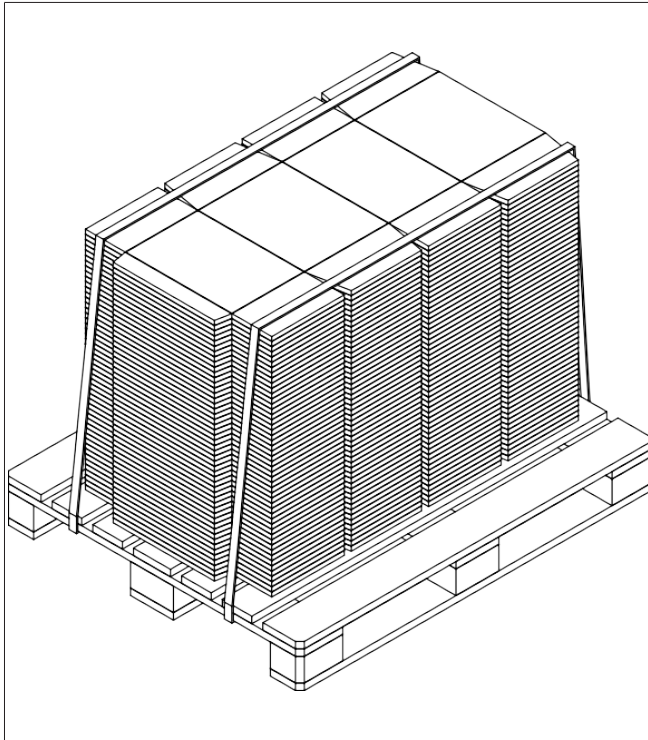

Fig. 1: Incorrect palletising

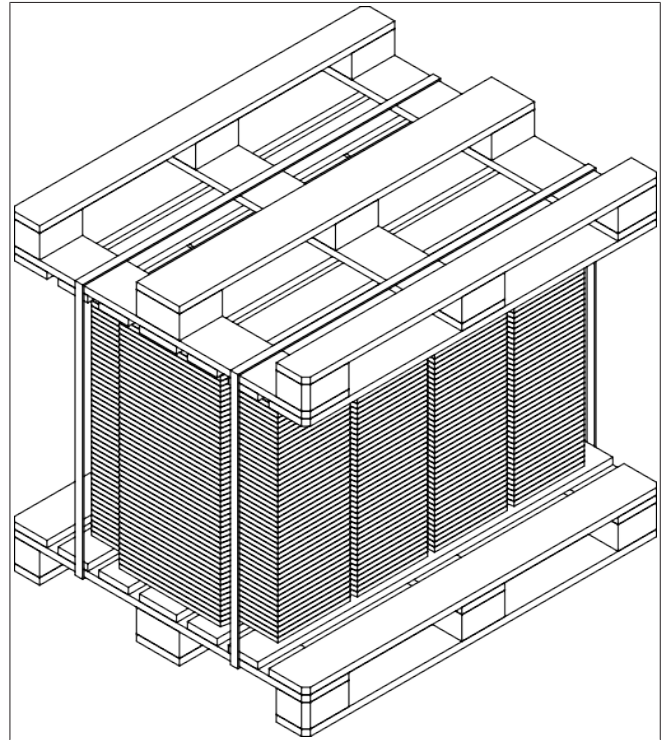

Fig. 2: Correct palletising

The conditioning of packers is extremely important, as card (paper) is a hygroscopic material and therefore absorbs moisture from its surroundings. This causes the mechanical stability in particular to change depending on the moisture content. Excessively hot and dry storage conditions can cause the material to ignite.

The stack must be provided with a top board. The bottom and top board must be strapped. Strapping should only be removed from the pallet when the blanks are used at the packer. Opened pallets must be covered with top boards.



## 2 Corrugated cardboard

### 2.1 General information

Corrugated cardboard and solid board offer ecological as well as economic advantages compared with other packaging types:

- Produced entirely from wood, a renewable raw material
- Reduction in the generation of waste by recycling paper and carton
- Non-recycled corrugated cardboard can be burned in suitable systems. It can therefore be used to generate heat and electricity.
- Corrugated cardboard is biodegradable.
- Its structure gives it high stability and damping.
- As corrugated cardboard is manufactured from waste paper, it is a cost-effective packing material.

### 2.2 Requirements for corrugated cardboard

- The liners and the corrugated members must be firmly glued together (see DIN 55468).
- Liner paper with low air permeability facilitates the handling of corrugated cardboard packages by means of vacuum cups.
- A standard permeability value of 400 ml/min (Bendtsen) should not be exceeded.
- Outer and inner liners of the same grammage improve the flatness of the corrugated cardboard packaging.
- At a vacuum of -0.5 bar there must be no apparent adhesive effect on the rear side due to low pressure.

### 2.3 Usable materials

According to specifications in DIN 55468:

- Single-wall: C-corrugation, B-corrugation, E-corrugation
- Multi-wall: E/B flute

The top, inner and layer pad can consist of Kraftliner but also recycled paper. Kraftliner papers are mostly used in humid environments on overseas transports or on printed images that require a high print quality. The individual grammages of the top/inner and layer pad and of the flute depend on the material used.

Layers	Grammage
Cover pad	105 - 400 g/m <sup>2</sup>
Shaft	80 - 200 g/m <sup>2</sup>
Inner/layer pad	80 - 300 g/m <sup>2</sup>



# Corrugated cardboard

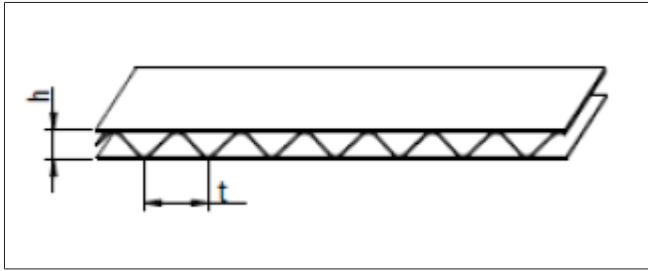

h = Flute height  
t = Flute pitch

Fig. 3: Flute structure

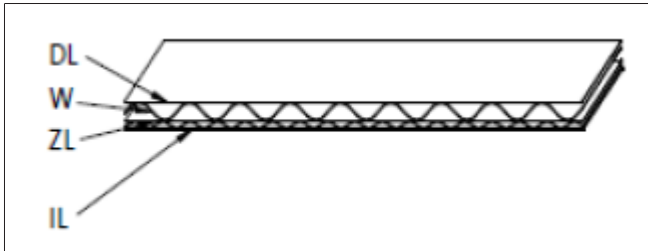

DL = Top layer  
W = Flute  
ZL = Layer pad  
IL = Inner layer

Fig. 4: Structure of corrugated cardboard

## 2.3.1 C flute

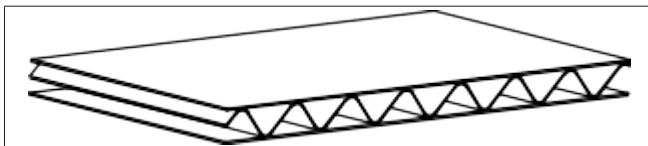

Flute pitch t	6.5 – 7.9 mm
Flute height h	3.1 – 4.0 mm
Flutes per m	127 – 147 1/m

Fig. 5: C flute

## 2.3.2 B flute

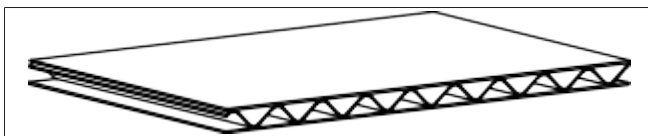

Flute pitch t	4.8 – 6.5 mm
Flute height h	2.2 – 3.1 mm
Flutes per m	154 – 182 1/m

Fig. 6: B flute

## 2.3.3 E flute

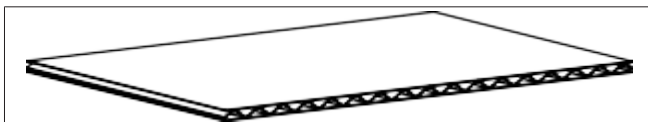

Flute pitch t	2.6 – 3.5 mm
Flute height h	1.0 – 1.9 mm
Flutes per m	286 – 385 1/m

Fig. 7: E flute





### 2.3.4 E/B flute

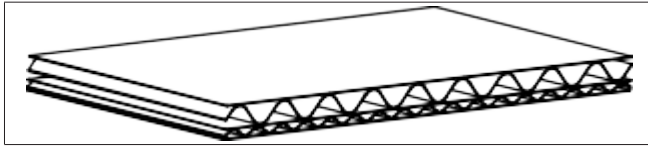

Flute pitch t	See E and B-flute
Flute height h	4.4 - 4.6 mm
Flutes per m	See E and B-flute

Fig. 8: E/B flute

The correct choice of flute depends on the demands place on the subsequent carton.

### 2.3.5 Examples of corrugated cardboard packaging

With regard to the individual packaging types, consultation with the Packaging and Palletising Technology Department at KRONES AG is urgently required.

Examples of corrugated cardboard packaging



Fig. 9: Corner tray



Fig. 10: Octagonal tray



Fig. 11: Carton with cover flaps



Fig. 12: HSC carton



Fig. 13: Display



Fig. 14: Wraparound carton



Fig. 15: Wraparound carton



Fig. 16: Open wrap-around carton



Fig. 17: U-pad



Fig. 18: Flute-pad



Fig. 19: Pad

## 2.4 Bending rigidity

Bending rigidity is the term used to describe the resistance with which a sample opposes the bending operation. This mechanical property is of decisive importance for the operating characteristics on a packer. Accordingly it is necessary to reduce the bending rigidity of the unprocessed carton. Typically, suitable scoring (plastic material deformation) will reduce the bending rigidity by approx. 50 percent.

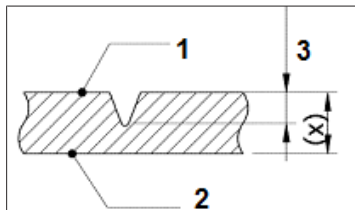

Fig. 20: Scoring

1. Inside
2. Outside
3. Approx. 50 %

The degree to which the bending rigidity is reduced by the scoring can be defined by the parameters "scoring depth" and "scoring width". For this purpose, the bending lines are examined more closely.

The bending lines must be precisely ordered and aligned and must be sufficiently stiff compared with the stiffness of the carton. This is designed to minimise any bulging out of the side and lid tabs and to remove unnecessary tension from the erection and seaming processes.

The folding creases on the cartons must be sufficiently pronounced that the restoring forces do not erect the carton again after it has been folded. To ensure that the bending rigidity has been sufficiently reduced at the bending lines, the test setup described in the Appendix is used.

Despite a reduction in the bending resistance with the help of the creasing at the bending edges, folding at angles of more than 90 degrees results in a sharp increase in bending force.

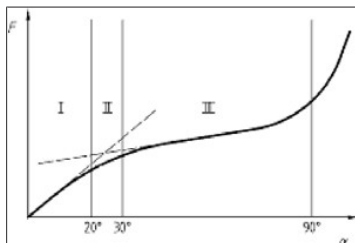

Fig. 21: Function of bending angle and bending resistance

- $\alpha$  = Bending angle  
 $F$  = Bending resistance

This non-linear grade can be explained with the formation of a bead. The bead is supported on the carton sides on the inner side of the bend and increases the required bending force. The bead, or its manifestation and effect on the required bending force, is a direct indication of the quality of the crease. A



force of 3 Newton can be assumed as a limit value at every angle for the maximum bending force on a bending line. This is a sample value for a sample width of 50 mm and varies as the sample width changes.

## 2.5 Types of cut-outs

The cartons must be punched out beyond the inner folding crease, so that the lids can be folded more easily. The exact distance between the inner bending line and the cut-out depends on the material and the size of the carton.

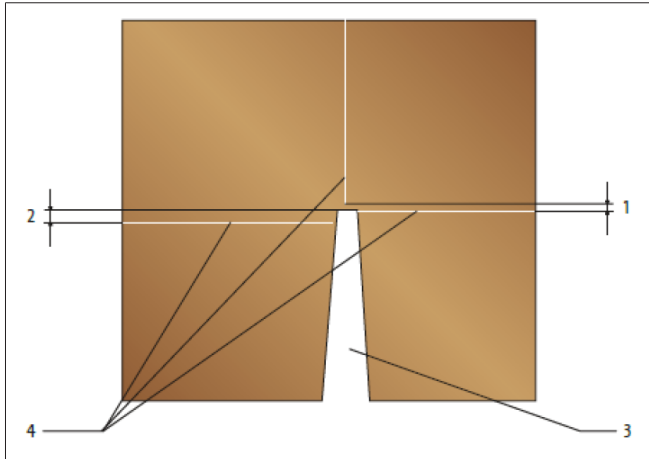

1. Half carton thickness
2. Full carton thickness
3. Cut-out
4. Folding creases

Fig. 22: Cut-out

### 2.5.1 Variants of the cut-outs and workability on the machines

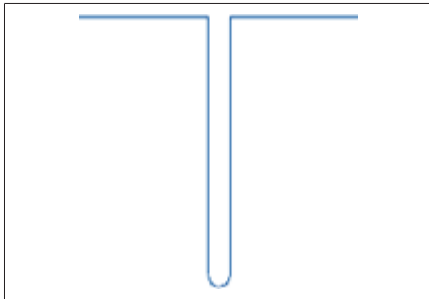

Fig. 23: Variant 1

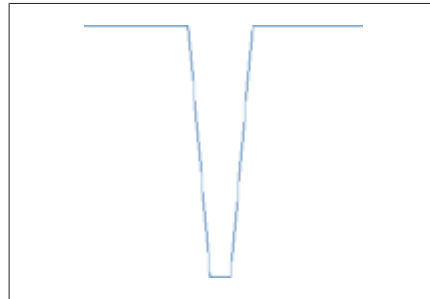

Fig. 24: Variant 2

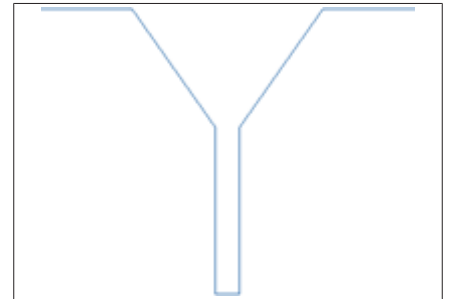

Fig. 25: Variant 3

	Variant 1	Variant 2	Variant 3
Variocart/Variocol*		X	X
Variopac		X	
Varioline	X	X	X

This assignment is only preferable for processing in order to provide an insight in advance as to which contour can be processed best. For example, if there is a need for Variant 1 with a Variocart/Variocol machine, it is necessary to consult the specialist department.

\*On the Variocart/Variocol carton machine, the punch-out is usually only angled on one side.



Fig. 26: Cut-out 1

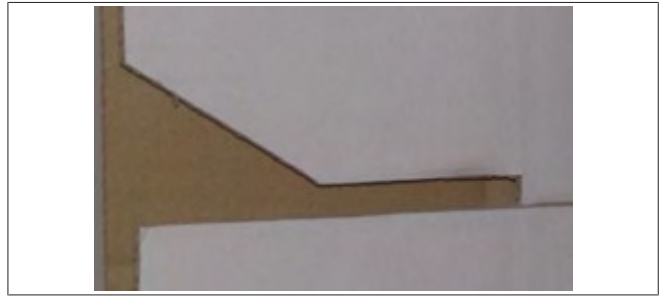

Fig. 27: Cut-out 2

## 2.5.2 Orthogonal cut-outs

Depending on the size of the cut-out, processing using the orthogonal arrangement of edges, as described in the image below, is possible both on the Variopac machine and on the Varioline and Variocart machines. To guarantee optimum processing quality, consultation with the relevant technical department is required.

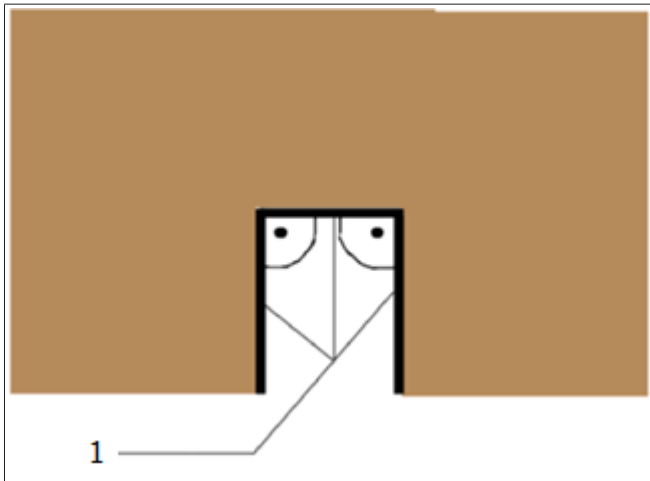

Fig. 28: Orthogonal cut-out

1. Orthogonal cut-out

## 2.6 General tolerances

The tolerances and dimensions of corrugated cardboard packages are defined in the VDW (Association of German Corrugated Cardboard Manufacturers) test catalogues as well as in DIN 55429 Part 2. It is desirable that the actual values are below the values specified in these publications.

### 2.6.1 Measurement requirements

A measurement may be taken only under standardised conditions (DIN 50014) at 23 °C and 50 percent humidity, as the dimensions may fluctuate, e.g. due to absorption of moisture. In addition to the change in climatic conditions, factors such as the precision of production tools, packaging material thickness and/or grammage can influence the dimensional accuracy.

The dimensions should be determined on the blank laid out flat. The dimensions of cartons apply from the crease line centre to crease line centre.



### 2.6.2 Tolerances for creasing and cutting dimensions

Packaging type	Tolerance
Punched packaging	± 2 mm
Carton with cover flaps / HSC box	± 3 mm

**The following applies:** The packaging result depends very much on the tolerances!

### 2.6.3 Tolerances for maximum deflection

- Max. deflection is  $x = 2.0$  percent of the blank length and/or blank width and of the diagonal.
- Permissible tolerance with regard to the geometrical dimensions < 0.5 percent

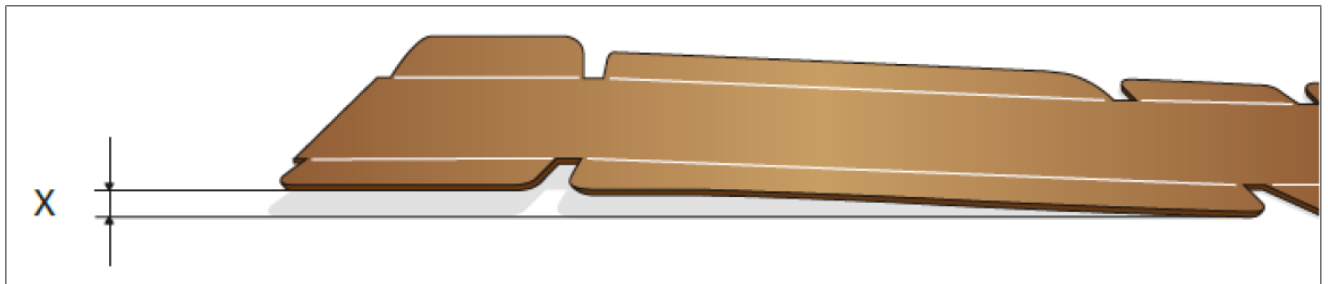

Fig. 29: Max. deflection

### 2.6.4 Gluing the flute

Starch-based glues are generally used for gluing the paper webs. The flutes must be firmly glued to the flat web at all flute crests. Gluing is considered to be flawless if torn fibres are visible on the adjacent flute or flat web on at least 80 percent of the glued surface when the flat webs are carefully torn off in the longitudinal flute direction. This applies to a sample size of 250 mm x 250 mm.

## 2.7 Printing on cardboard containers

To avoid processing problems with printed or lacquered cardboard, containers, consultation with the Packaging and Palletising Technology Department of KRONES AG is recommended.

## Corrugated cardboard

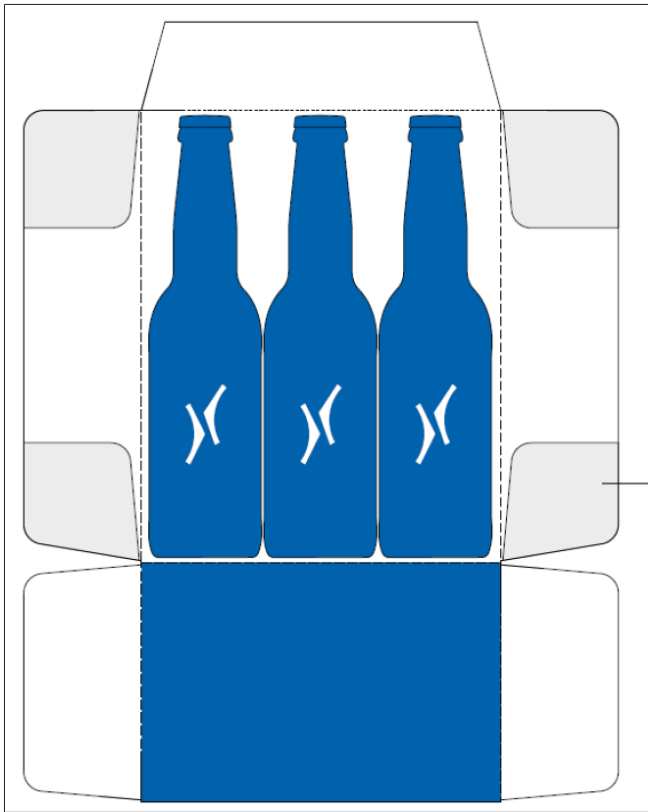

Fig. 30: Unpainted gaps for glue points

With certain machine designs it is possible to amend complex representations (e.g. QR codes) subsequently. To ensure optimum printing conditions for these representations, you must pay attention to the material, the quality and the possible presence of existing printing when selecting the printer.

## 2.8 Carrying strap – wrap-around carton

### 2.8.1 Glued carrying strap with counter-tab

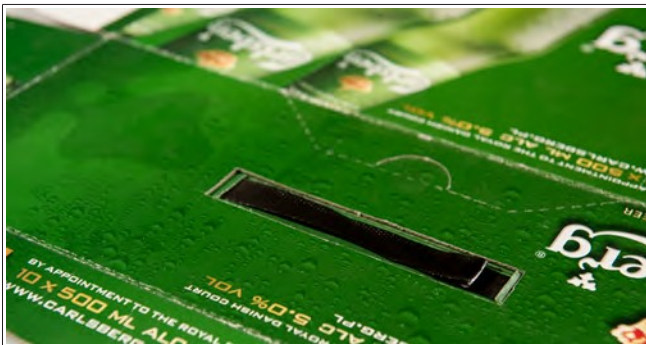

Fig. 31: Flat-lying blank with inside and outside



Fig. 32:

The integrated handle is placed in a recess of the blank and is held by means of a counter-flap. Furthermore, the carrying strap is secured with a fixture (glue point or similar) in such a way that the loop does not protrude over the carton (see also illustration). In addition, the counter-tab must be as thin as possible (max. 10 mm height difference of the stack to be inserted).



Fig. 33: Representation erected



Fig. 34:

### 2.8.2 Integrated carrying strap by cut-out



Fig. 35: Blank flat



Fig. 36: Blank erected

If integrated carrying straps are created by cut-outs, attention must be paid to the parallel placement of the inner edges. The distance of the inner edges must be selected to ensure sufficient stability. The distances depend on the material used and the requirements (e.g. weight to be supported) of the carton.

### 2.8.3 Plastic carrying strap inserted into recess

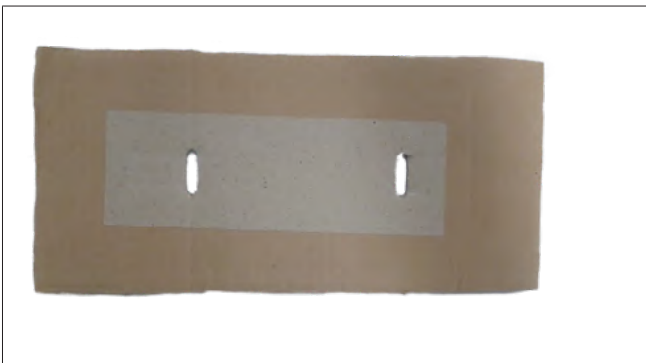

Fig. 37: Cut-out without carrying strap



Fig. 38: Cut-out with carrying strap



Fig. 39: Carrying strap top view

The carrying straps that consist largely of plastic are inserted into pre-punched recesses. The optimum width and length of the recess must be individually selected for the carrying strap to be inserted. Plastic straps are not inserted by the machine, but must be manually inserted. Depending on the carrying strap, it may be necessary to pay attention on the orientation of the upper and lower sides. For instance, if one side is ergonomically shaped, the arrangement of sides is derived from this.

Apart from simply inserting the carrying straps into the cut-outs, it is possible to secure the carrying straps using a plastic counter-tab. The counter-tab must be manually inserted, but offers the advantage of enhanced stability compared with simple insertion into the cut-out.



Fig. 40: Plastic connection

The plastic connection should be less than one millimetre thick. To guarantee optimum attachment, attention must be paid to the recesses of the connection and on inserting the handle in the correct alignment. The width and length of the recesses in the plastic counter-tab depend on the carrying strap used. With carrying cartons in particular, it may be necessary to insert the carrying straps through two recesses at both sides to increase stability.

To avoid processing difficulties, it is necessary to consult with the Packaging and Palletising Technology Department at KRONES AG before processing the packaging with plastic carrying handles.





Corrugated cardboard



Fig. 41: Recess for handle



Fig. 42: Inserting the grip



Solid board

## 3 Solid board

### 3.1 Delivery and storage of pre-glued blanks

In general, the delivery and storage specifications mentioned above should be observed. Since pre-glued blanks are generally delivered shrink-wrapped or wrapped, bear in mind the following:

- As much dust and chad as possible must be removed from the blanks.
- The blanks must be easily stackable.
- The stacked blanks must be easy to separate and must not get caught in the stack.
- The blanks must lie flat and must not become bent or deformed when transported.
- The orientation of the blanks in the transport pack must always be the same.
- The moisture content of the delivered material will affect workability. The set-point for delivery is 5 – 8 percent. This can be measured using a rod hygrometer.
- Storage of the wrapped or shrink-wrapped pallet
- If processing conditions are humid, the film around the pallet may be removed just before the actual processing.
- Part-pack quantities must be packaged resistant to moisture again before storage.

#### 3.1.1 Outer packaging

Pre-glued blanks can be delivered in a variety of external packaging types.

- HSC box (Half-Slotted Container)
- Carton with cover flaps (Regular Slotted Container)
- High-edge tray
- On a pallet wrapped in film
- With layer pads

The magazine chute can be filled directly through external packaging that has been opened at one side. This is only possible if the external packaging is opened at the flat side of the pre-glued blanks.

It should be noted at this point that the terms "solid board" and "Kraft board" are used synonymously. The following section uses the term "solid board" exclusively.

Along with a uniform material structure, the recycled packaging material solid board displays good strength properties and adequate stiffness. It is homogeneous with a high material density, has a sealed and smooth surface, uniform thickness, optimum flatness, low compressibility and offers exceptional printability in all common printing processes.

Although heavier than other packaging materials, corrugated cardboard and solid board offer numerous ecological and economic advantages:

- Produced entirely from wood, a renewable raw material
- Reduction in the generation of waste by recycling paper and carton
- Today almost 100 percent of solid board is manufactured from cost-effective secondary raw material, i.e. waste paper.
- Solid board is biodegradable.

However, the correct packaging depends on its use and the shape and weight of the packaged goods.



## 3.2 Requirements for solid board

In addition to continuous inspections by the manufacturer, there are several standards that should be observed to ensure optimum processing.

- Burst test (according to DIN ISO 2758)
- Penetration test (according to DIN 53142)
- Bending rigidity (according to DIN 53121/DIN 53122)
- Crush test (according to DIN EN 22872/22874)
- Impact test (according to DIN ISO 22248)

Low air permeability facilitates the handling of the packaging by means of vacuum cups. A standard permeability value of 400 ml/min (Bendtsen) should not be exceeded. On the other hand, at a vacuum of -0.5 bar, there must be no detectable adhesive effect on the rear side due to the vacuum (test using paper sensor).

## 3.3 Examples of solid board packaging

Solid board packaging types



Fig. 43: Over-Top Open



Fig. 44: Over-Top Partly Closed

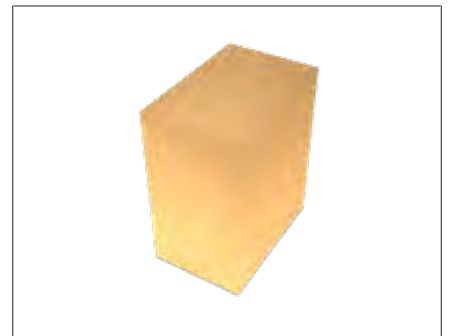

Fig. 45: Over-Top Closed



Fig. 46: Open Basket



Fig. 47: On-Top Clips



Fig. 48: Closed Basket



### 3.4 Bending rigidity

Bending rigidity is the term used to describe the resistance with which a sample opposes the bending operation. This mechanical property is of decisive importance for the operating characteristics on a packer. Solid board has a different fibre orientation. In Type A, the fibres are orthogonal to the bending point, while the fibres in Type B are parallel to the bending point.

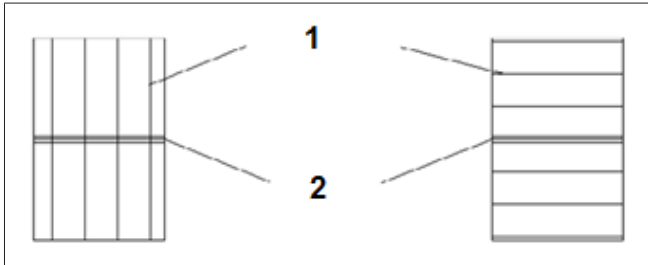

Fig. 49: Bending rigidity

Material thickness/density	0.5 mm - 320 g/m <sup>2</sup>	0.5 mm - 320 g/m <sup>2</sup>
Printing/coating	Printed on one side	Printed on one side
Measurement for fibre orientation type A/type B	Type A	Type B
Sample width	40 mm	40 mm
Sample length	62 mm	62 mm
Measured length	15 mm	15 mm
Bending of the sample	90 °	90 °
Temperature	23 °C	23 °C
Relative humidity ± 1 %	50 %	50 %

Within these framework conditions, the following material requirements apply to the different bending lines.

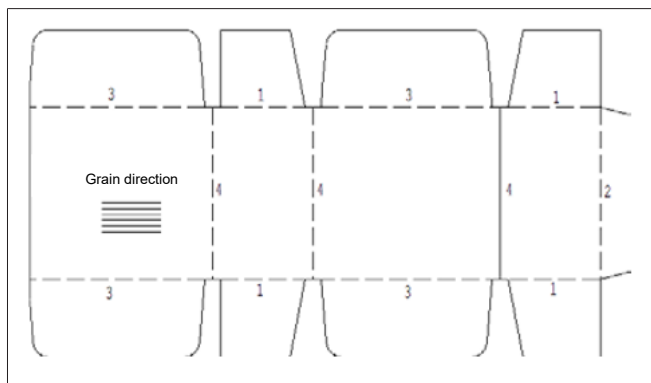

Fig. 50: Blank

Item number	min.	Max
1	5 mNm	7 mNm
2	8 mNm	10 mNm
3	10 mNm	12 mNm
4	15 mNm	17 mNm

The values are guide values which may deviate due to the type of pack and the properties of the carton. Should the characteristics differ from the values mentioned above, consultation with the Packaging and Palletising Technology Department at KRONES AG is essential.



## 3.5 Tolerances

### 3.5.1 Measurement requirements

- A measurement may be taken only under standardised conditions (DIN 50014) at 23 °C and 50 per cent humidity, as the dimensions may fluctuate, e.g. due to absorption of moisture.
- The dimensions should be determined on the blank laid out flat.
- The dimensions of cartons apply from the crease line centre to crease line centre.
- The fold lines/bending lines must be precisely ordered and aligned and must be sufficiently stiff compared with the stiffness of the carton.
- This is designed to minimise any bulging out of the side and lid tabs and to remove unnecessary tension from the erection and seaming processes.
- The folding creases on the cartons must be sufficiently pronounced that the restoring forces do not erect the carton again after it has been folded.

### 3.5.2 Tolerances for creasing and cutting dimensions and maximum deflection

The following influencing factors on the dimensional accuracy always apply:

- Machine equipment and production method
- Precision of production tools
- Packaging material thickness or area-related mass

For punched boxes made of solid board (flat-bed or rotation-stamped boxes), the following tolerance formula applies depending on the mass:

Basic tolerance:	±0.4 %, plus
Material dependent:	±0.05 mm per 100 g/m <sup>2</sup> area-related mass of the packaging material
Production-dependent:	± 0.4 mm
However a total maximum of:	±1 mm per edge length

Higher tolerances result when manufacturing in other processes, e.g with bending and slotting machines. The following tolerance formula applies to these:

Basic tolerance:	±0.4 % depending on mass, plus
Material dependent:	±0.05 mm per 100 g/m <sup>2</sup> area-related mass of the packaging material
Production-dependent:	± 0.6 mm
However a total maximum of:	±1.5 mm per edge length

- Max. deflection is  $x = 2.0$  percent of the blank length and/or blank width and of the diagonal.
- Permissible tolerance with regard to the geometrical dimensions < 0.5 percent

## 4 Cardboard specification

### 4.1 Folding and bending properties

#### 4.1.1 Folding properties

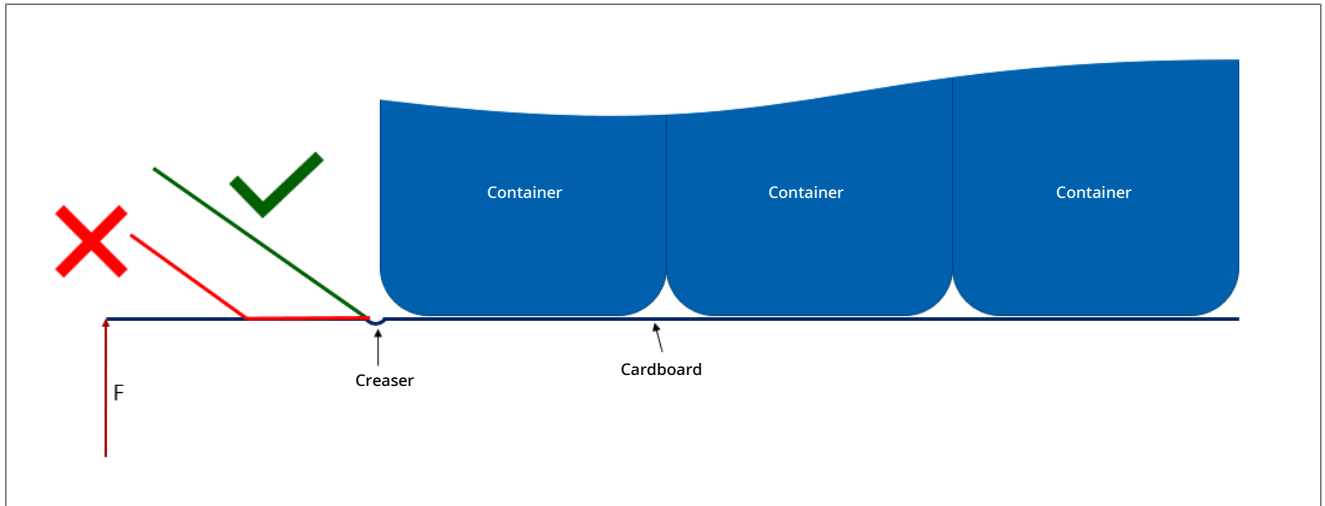

Fig. 51: Folding properties

#### 4.1.2 Bending properties

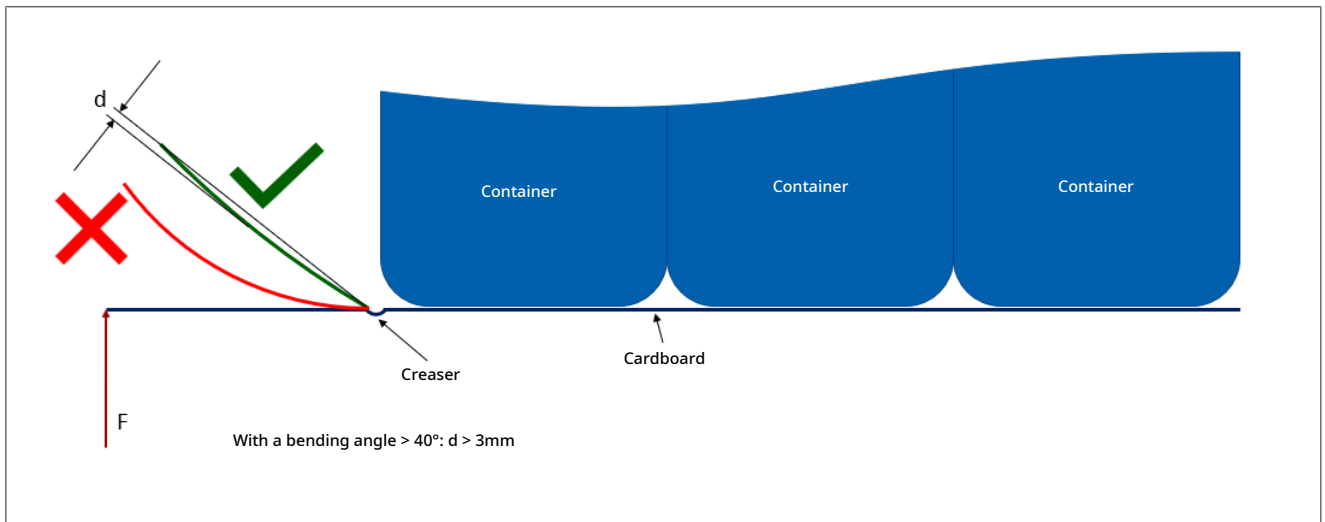
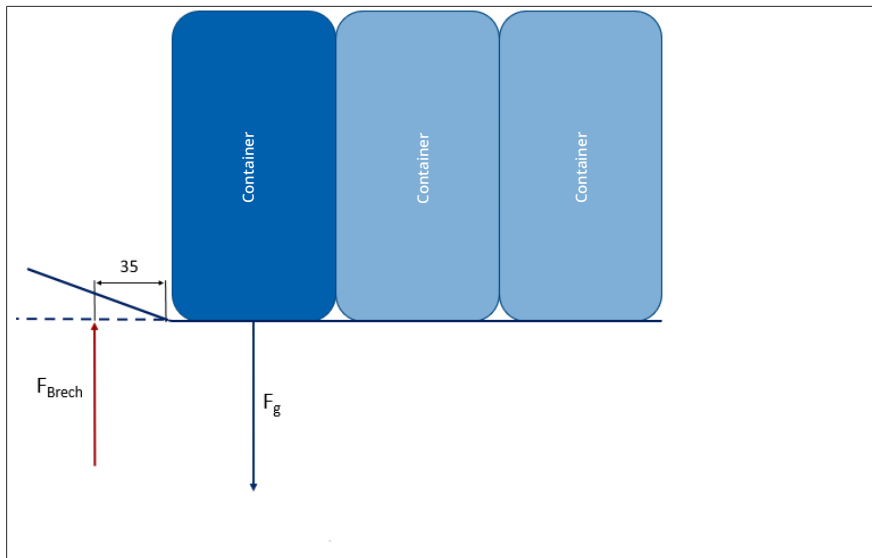

Fig. 52: Bending properties

### 4.1.3 Correlation between carton weight and container weight



Multi-row packs:

$$\blacksquare F_{\text{break}} < 0.75 \times F_g \times n$$

Single-row packs:

$$\blacksquare F_{\text{break}} < 0.375 \times F_g \times n$$

$$F_g = m_{\text{container}} \times g$$

$F_{\text{break}}$  = required force to break the creasing

$n$  = number of containers tangent to the breaking edge

Fig. 53: Correlation between carton weight and container weight

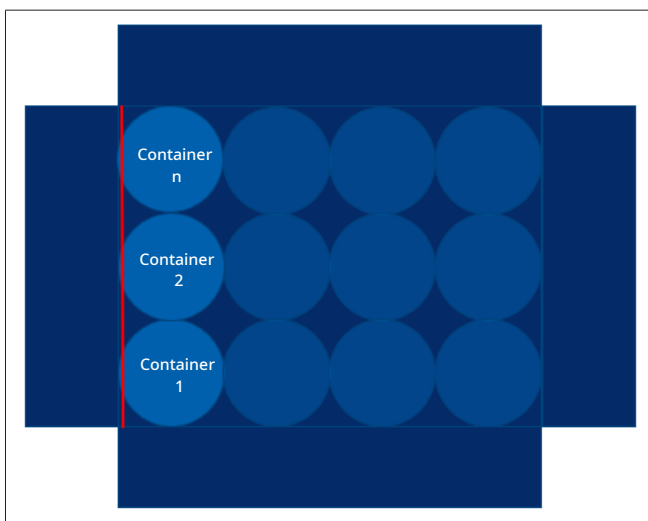

Fig. 54: Correlation between carton weight and container weight

## 4.2 Wrap-around cartons

The wrap-around carton consists of a flat blank, on which the side walls, the lid and the glue tabs are hinged on the base of the carton. The feature of the wrap-around packaging is that a mechanical process erects the carton into a »U«, fills it with the product and then glues the carton. The product is tightly enclosed by the carton in such a way that eliminates gaps. This eliminates the possibility of damage caused, for example, by the products banging against one another inside the carton during distribution. Wrap-around packaging can be made from corrugated or solid board. In selecting the material, the demands placed on the subsequent packaging (particularly the required stability) must be taken into account.



Fig. 55: Wrap-around carton, flat blank



Fig. 56: Wrap-around carton, folded

#### 4.2.1 Erecting process of a wrap-around carton (Variopac)

Wrap-around carton, folding process

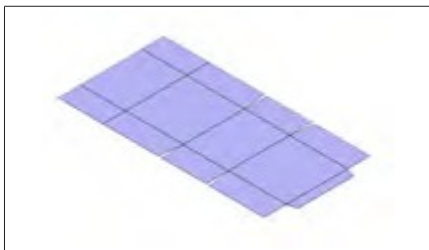

Fig. 57: 1. As-delivered state

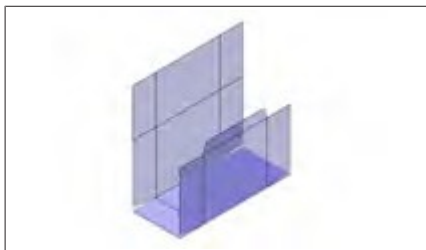

Fig. 58: 2. Erecting the side walls

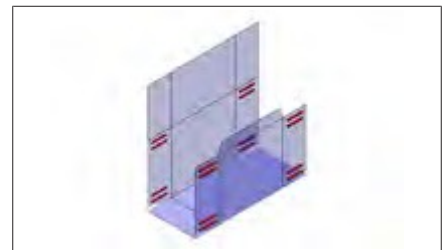

Fig. 59: 3. Gluing the inner tabs

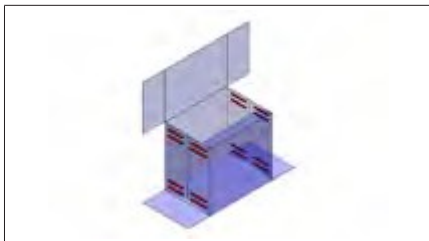

Fig. 60: 4. Folding in the inner tabs

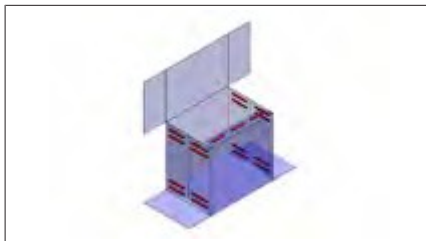

Fig. 61: 5. Gluing the joint tabs

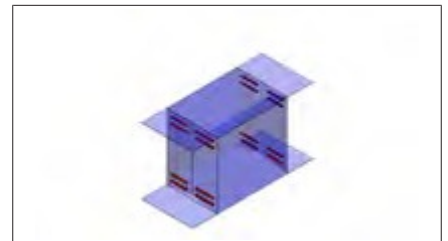

Fig. 62: 6. Folding in the outer tabs

#### 4.2.2 Tolerances with regard to wrap-around cartons

When the blanks are delivered, attention should be paid to ensuring good flatness and low deflection. Correct cuts in the recesses are essential to ensure a flawless sequence in the machine.

The inner tabs of the wrap-around cartons must be angled at the ends so that they can be folded in correctly.



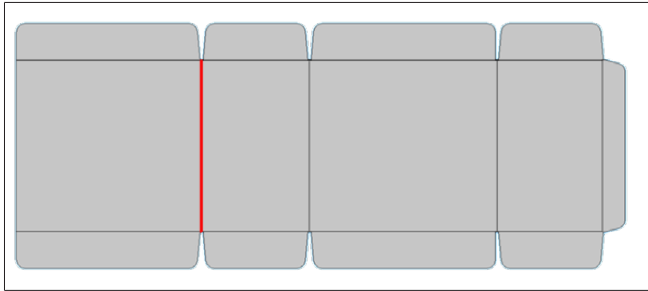

Fig. 63: Wrap-around carton, edge

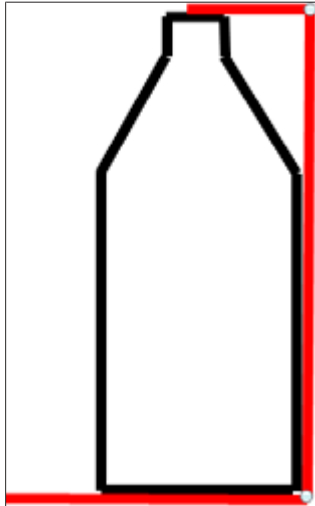

Fig. 64: Wrap-around carton, illustration of joint tab

The joint tab must extend to at least half the container neck to guarantee adequate stability.

The bending rigidity at all edges, with the exception of the edge shown in red in the picture, is reduced by approx. 50 percent with the help of creasing. The bending rigidity on the edge marked in red is also reduced by creasing, but by less than 50 percent.

It is important to position the carton correctly when inserting it into the machine. This is dictated by the running direction of the carton and varies with the different wrap-around cartons.

### 4.2.3 Difference between a carton with cover flaps and a wrap-around carton

- Starting product and course of both carton types in the machine  
Cartons with cover flaps are pre-folded and glued on one side before they enter the machine. The machine erects the cartons, glues the base, places the product into the carton and seals it. In contrast, the wrap-around carton is folded around the product. The product is placed on the subsequent base of the carton, the carton is folded around the product and glued.
- Stability  
Cartons with cover flaps are more stable than wrap-around cartons due to the rectangular arrangement of their edges. Wrap-around cartons are much less able to compensate for vertical forces than cartons with cover flaps.
- Resealability  
Thanks to their design, cartons with cover flaps are easier to re-seal than wrap-around cartons.
- Susceptibility to product damage  
The closely-packed arrangement of bottles in wrap-around cartons makes them less susceptible to product damage than bottles packed in cartons with cover flaps. Due to the low or non-existent gaps between the containers, they cannot knock against and cause damage to one another.



Fig. 65: Carton with cover flaps



Fig. 66: Wraparound carton

### 4.2.4 Proposal drawing of a corrugated cardboard wrap-around carton

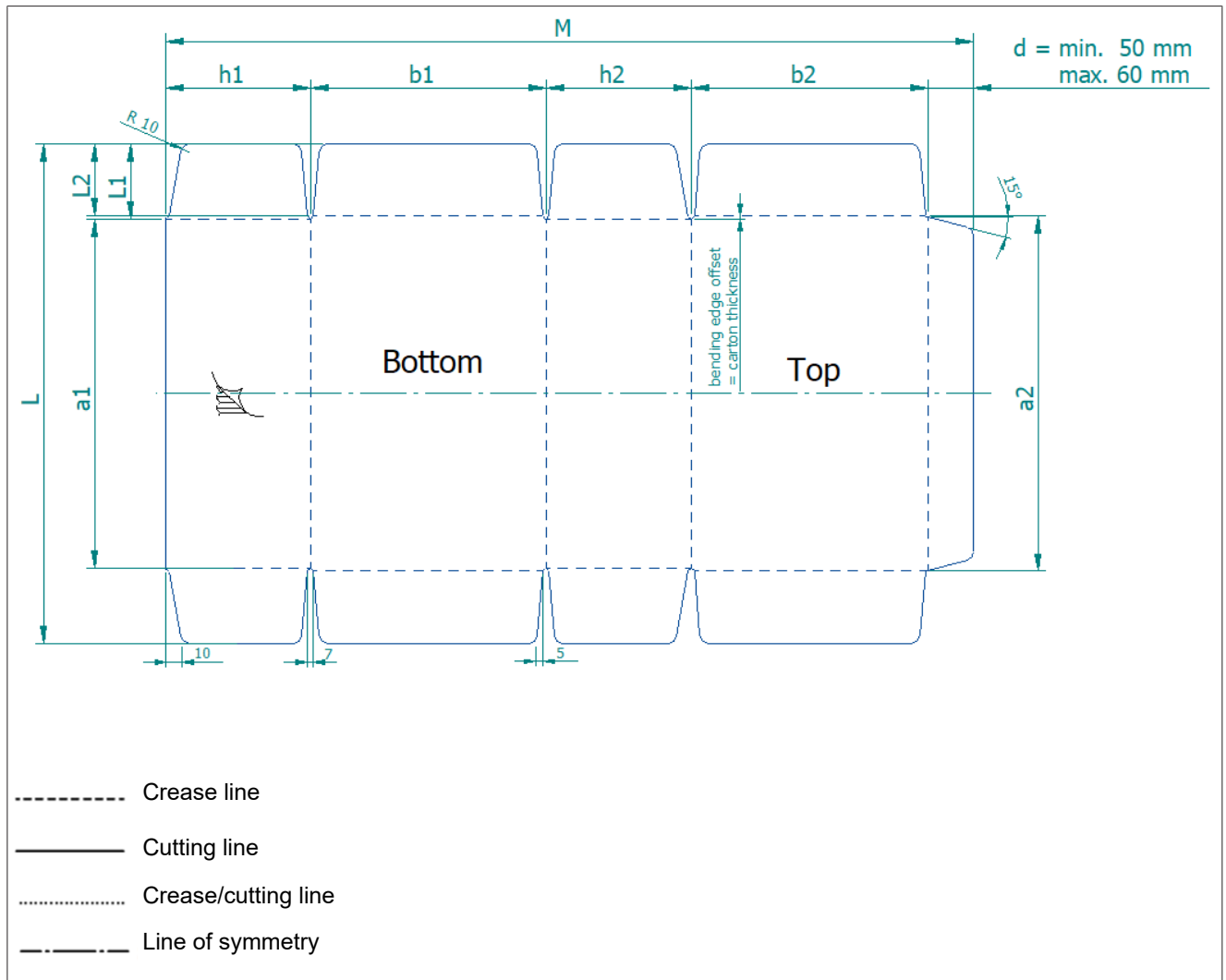

Fig. 67: Proposal drawing of a wrap-around carton

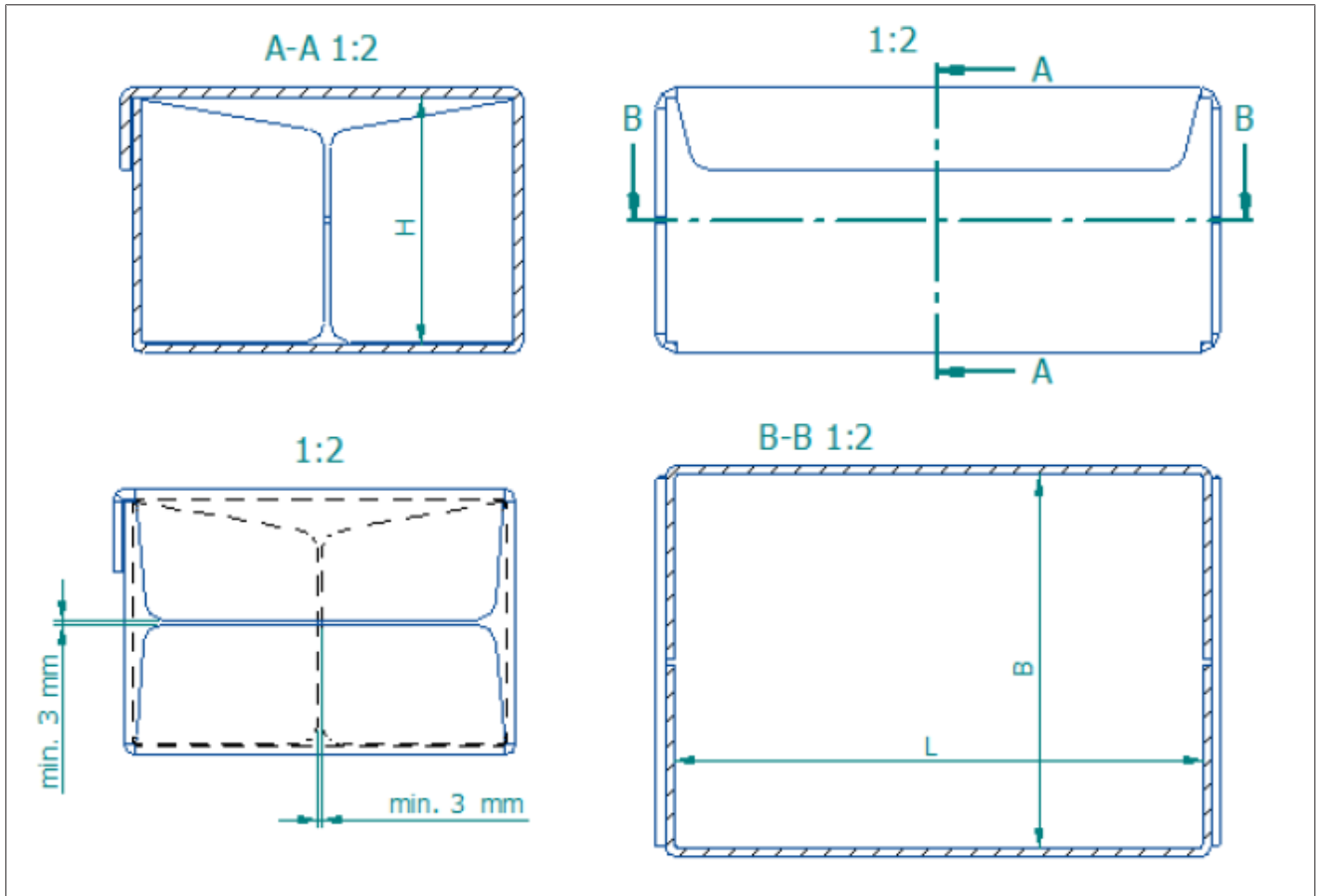

Fig. 68: Internal dimensions

Required criteria of Varioline:	<ul style="list-style-type: none"> <li>■ Keeping splicing points clear</li> <li>■ Bottom flap has outer bending edge (outside flap).</li> <li>■ Flaps easier to bend than lengthwise edging</li> <li>■ Bending edge offset = carton thickness</li> <li>■ Joint tab height: Min. 50 mm; max. 60 mm</li> <li>■ Joint tab angle = 15 °</li> <li>■ Slot width</li> <li>■ Slot length up to inner bending edge</li> </ul>
Optional criteria of Varioline:	<ul style="list-style-type: none"> <li>■ Joint tab outside</li> <li>■ Lid flap only creased</li> <li>■ Slots centred on bending line</li> <li>■ Slot radius tangential to inner bending edge</li> </ul>

\*) If bottles are packaged in wrap-around cartons made of solid board, consult with the technical department.

Flute type		E flute	B flute	C flute
a	Pack length <sup>1</sup>			
b	Pack depth <sup>2</sup>			
h	Pack height <sup>3</sup>			
x	Carton thickness	1.0-1.9 mm >1.5 mm	2.2-3.1 mm > 2.5 mm	3.1-4.0 mm > 3.5 mm
a1	$a1 = a + 2 \cdot \frac{1}{2} \cdot x$			
a2	$a2 = a + 2 \cdot \frac{1}{2} + 2 \cdot x$			
b1	$b1 = b + 2 \cdot \frac{1}{2} \cdot x$			
b2	$b2 = b + 2 \cdot \frac{1}{2} \cdot x + x$			
h1	$h1 = h + \frac{1}{2} \cdot x$			

Flute type	E flute	B flute	C flute
h2	$h2 = h + 2 \cdot \frac{1}{2} \cdot x + x$		
d	Joint tab	Min. 50 mm; max. 60 mm	
L1, L2	Tabs $\geq 60$ mm		
L	$L = a1 + b1 - 3$		
M	$M = h1 + h2 + b1 + b2 + d$		

## NOTICE

These values ONLY refer to the proposal drawing. A check of the dimensions by the specialist department is always necessary for each carton.

- 1) Pack length: Is calculated from the bottle diameter and corresponding formation (e.g. 4x3 formation).
- 2) Pack width: Is calculated from the bottle diameter and corresponding formation (e.g. 4x3 formation).
- 3) Pack height: Calculated from bottle height including cap.

### 4.2.5 Proposal drawing of a solid board wrap-around carton

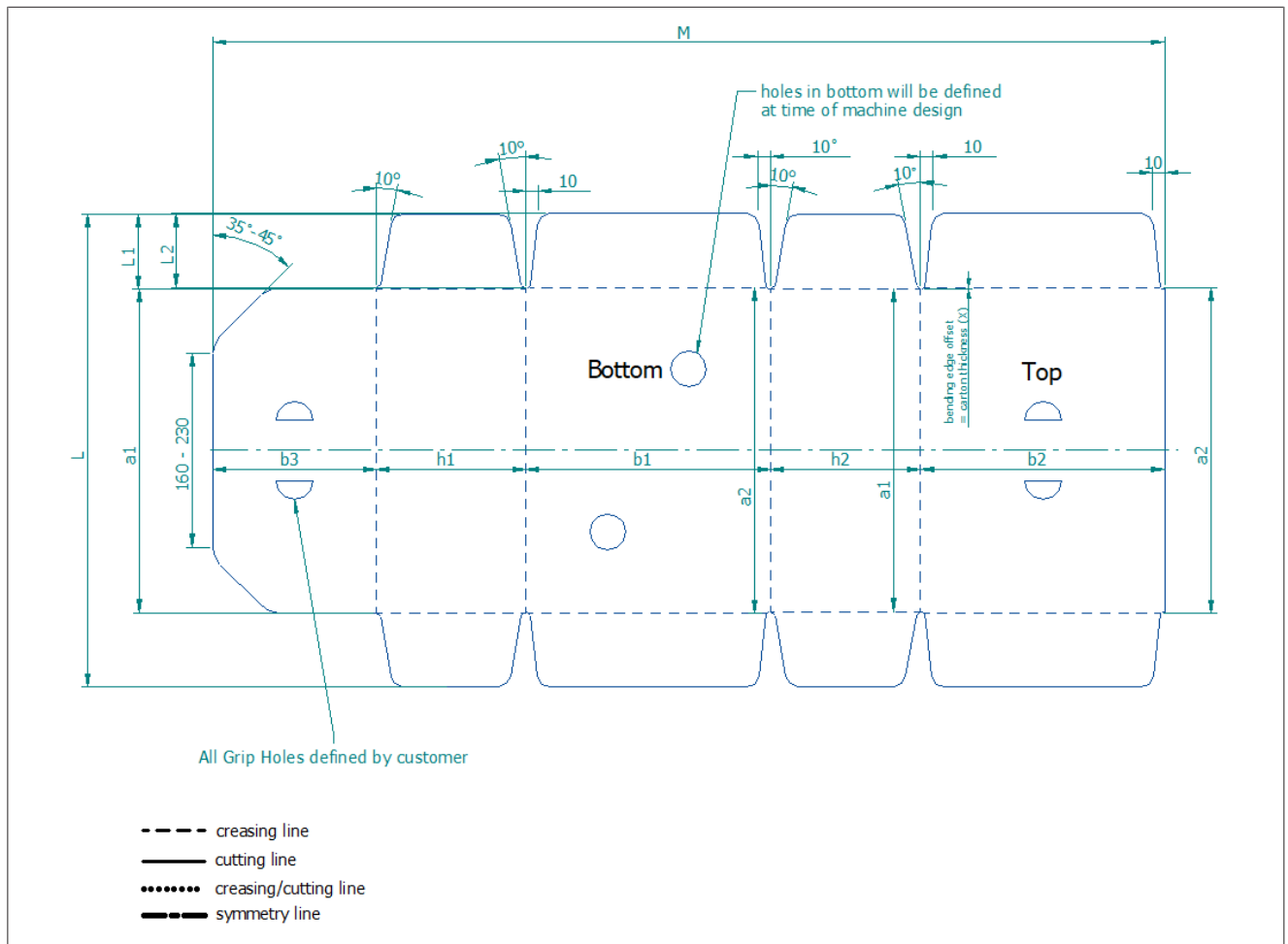

Fig. 69: Solid board wrap-around carton

Flute type	E flute	B flute	C flute
a	Pack length <sup>1</sup>		
b	Pack width <sup>2</sup>		
h	Pack height <sup>3</sup>		

Flute type		E flute	B flute	C flute
x	Carton thickness	1.0 – 1.9 mm 1.5 mm	2.2 – 3.1 mm 2.5 mm	3.1 – 4.0 mm 3.5 mm
a1	$a1 = a + 2 \cdot \frac{1}{2} \cdot x$			
a2	$a2 = a + 2 \cdot \frac{1}{2} \cdot x + 2 \cdot x$			
b1	$b1 = b + 2 \cdot \frac{1}{2} \cdot x$			
b2	$b2 = b + \frac{1}{2} \cdot x + x$			
b3	$b3 = b + \frac{1}{2} \cdot x$			
h1	$h1 = h + 2 \cdot \frac{1}{2} \cdot x$			
h2	$h2 = h + 2 \cdot \frac{1}{2} \cdot x + x$			
L1, L2	Tabs $\geq 60$ mm			
L	$L = a1 + b1 - 3$			
M	$M = h1 + h2 + b1 + b2 + b3$			

Tab. 1: Cartons

1. Pack length: Calculated from the bottle diameter and the corresponding formation (e.g. 4x3 formation)
2. Pack width: Calculated from the bottle diameter and the corresponding formation (e.g. 4x3 formation)
3. Pack height: Calculated from bottle height including cap

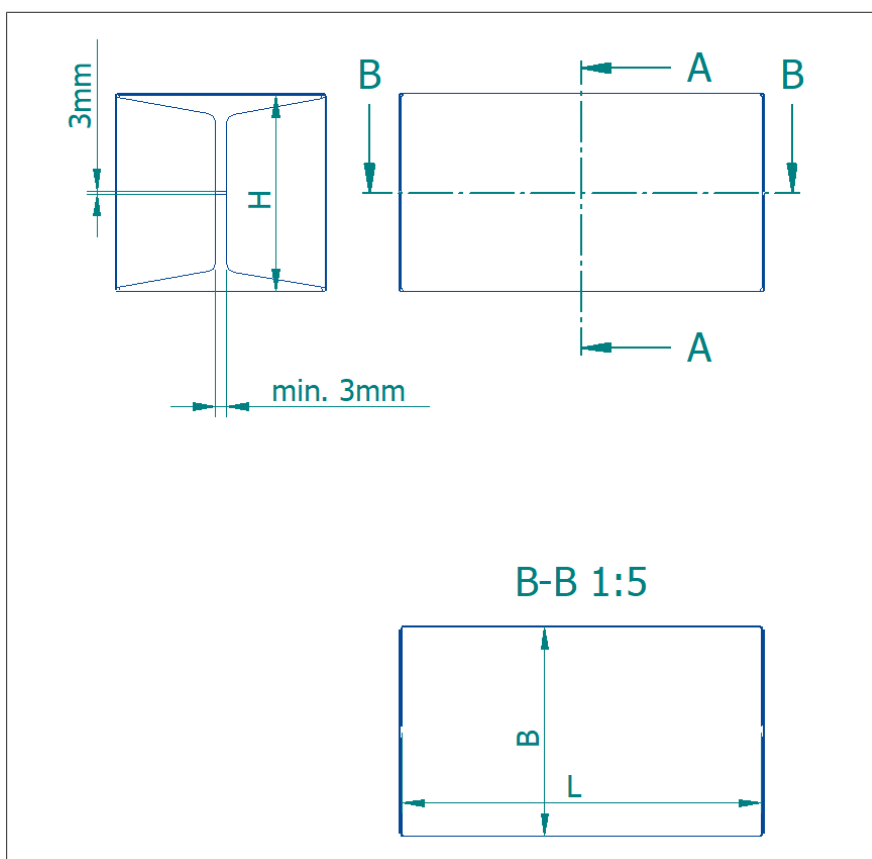

Fig. 70: Views of a solid board wrap-around carton

### 4.3 Cartons with cover flaps / American boxes

The edges of cartons with cover flaps or American boxes, as they are also referred to, are arranged on top of each other at right angles, making them an extremely stable means to package products. In addition to high levels of stability, they have the advantage of being re-sealable and consist of corrugated cardboard (standardised according to DIN 55468).

In addition to variations in format and flute type, customer-specific requests such as carrying loops can also be taken into account. Cartons with cover flaps are pre-folded and only need to be erected and glued in the machine. Gluing in a straight line on the high edge requires particular care as otherwise the edges on the base will not be parallel to one another.



Fig. 71: Display: knocked-down flat carton with cover flaps



Fig. 72: Display: erected carton with cover flaps



Fig. 73: Display: top view of a carton with cover flaps

There are two types of cartons with cover flaps: right-hand and left-hand cartons.

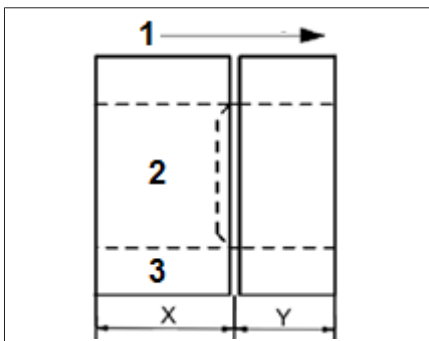

Fig. 74: Left-hand carton ( $x < y$ )

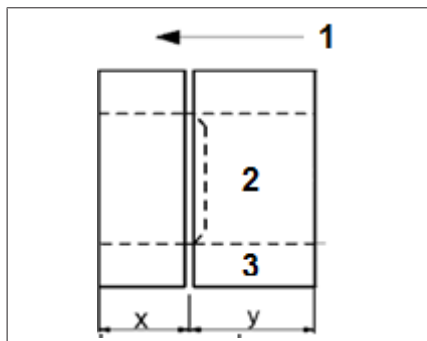

Fig. 75: Right-hand carton ( $x > y$ )

1. Erecting direction
2. Print
3. Bases
4. Left/right carton

The difference results from the arrangement of the wider edge  $x$  or  $y$  on the side with the pre-glued edge as well as from the orientation of the text on the cardboard container. The definition of the right-hand or left-hand carton defines the erection direction of the cardboard container.

The thickness of the pre-glued tabs must correspond to the thickness of the complete carton. This means that the thickness must be reduced at the splicing points, e.g. by pressing.

### 4.3.1 Proposal drawing of a carton with cover flaps (Varioline)

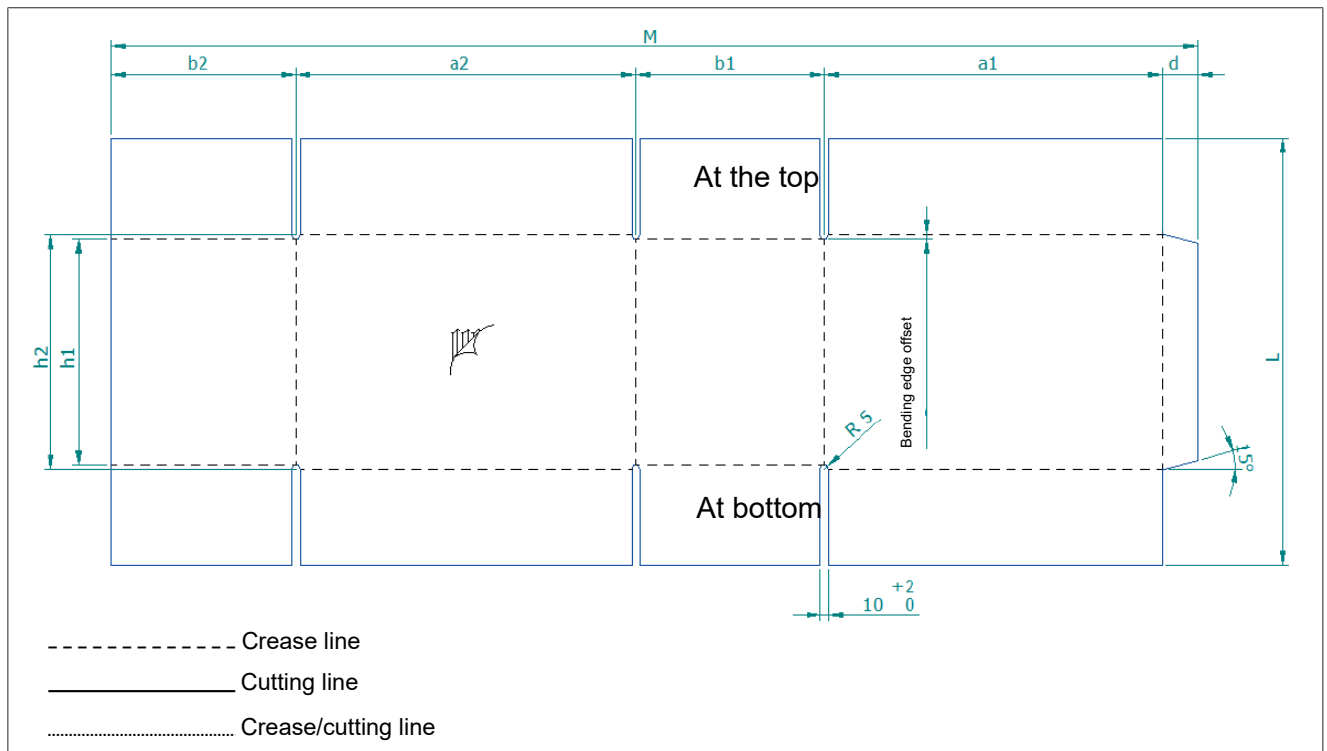

Fig. 76: Proposal drawing of a carton with cover flaps

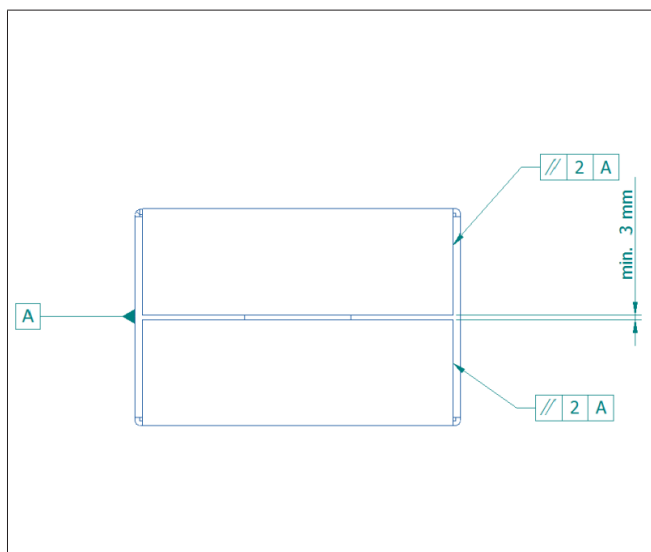

Fig. 77: Tolerances of a carton with cover flaps

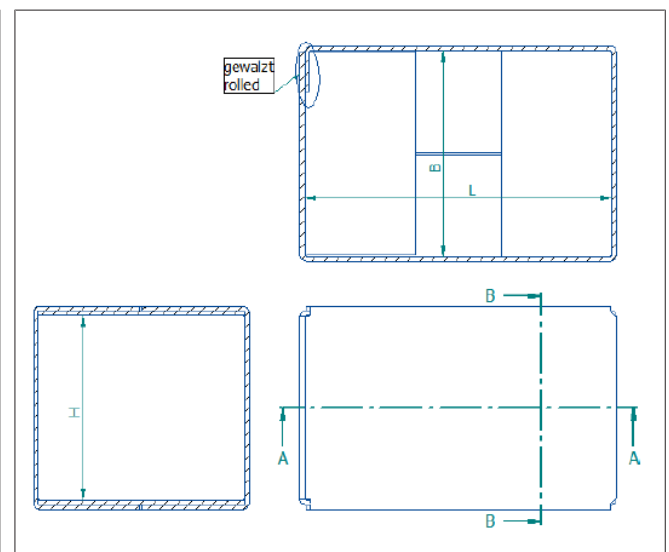

Fig. 78: Dimensions of a carton with cover flaps

Criteria required:

- For the minimum and maximum values, see the format range of the carton with cover flaps
- Joint tab rolled
- Keep splicing points free (splicing points are different for Variopac and Varioline)
- Slot between the flaps = 10 mm
- Length of the slots = height of inner flap
- Rectangularity
- Flap spacing when folded together at least 3 mm
- Gap for additional variants (dividers, basket, wrap-around carton)

## Cardboard specification

Optional criteria of Varioline:	<ul style="list-style-type: none"> <li>■ Joint tab on long side</li> <li>■ Flaps end at same height.</li> <li>■ Slot radius tangential to inner bending edge</li> <li>■ Slots centred on bending edge</li> <li>■ Bending edge offset = carton thickness</li> <li>■ Joint tab angle = 15 °</li> </ul>
---------------------------------	--

Flute type		E flute	B flute	C flute
a	Pack length <sup>4</sup>			
b	Pack depth <sup>5</sup>			
h	Pack height <sup>6</sup>			
x	Carton thickness	1.0-1.9 mm ->1.5 mm	2.2-3.1 mm -> 2.5 mm	3.1-4.0 mm -> 3.5 mm
a1	$a1 = a + \frac{1}{2} \cdot x \cdot x$			
a2	$a2 = a + 2 \cdot \frac{1}{2} \cdot x$			
b1	$b1 = b + 2 \cdot \frac{1}{2} \cdot x$			
b2	$b2 = b + \frac{1}{2} \cdot x$			
h1	$h1 = h + 2 \cdot \frac{1}{2} \cdot x$			
h2	$h2 = h + 2 \cdot \frac{1}{2} \cdot x + 2 \cdot x$			
d	Joint tab	Min. 20 mm; max. 45 mm		
L	$L = h1 + b1 - 3$			
M	$M = a1 + a2 + b1 + b2 + d$			

### NOTICE

These values ONLY refer to the proposal drawing. A check of the dimensions by the specialist department is always necessary for each carton.

<sup>4</sup>) Pack length:

Calculated from bottle diameter and corresponding pattern (e.g. 4x3 pattern).

<sup>5</sup>) Pack width:

Calculated from bottle diameter and corresponding pattern (e.g. 4x3 pattern).

<sup>6</sup>) Pack height:

Calculated from bottle height including cap



## 4.4 Proposed drawing of tray (Varioline)

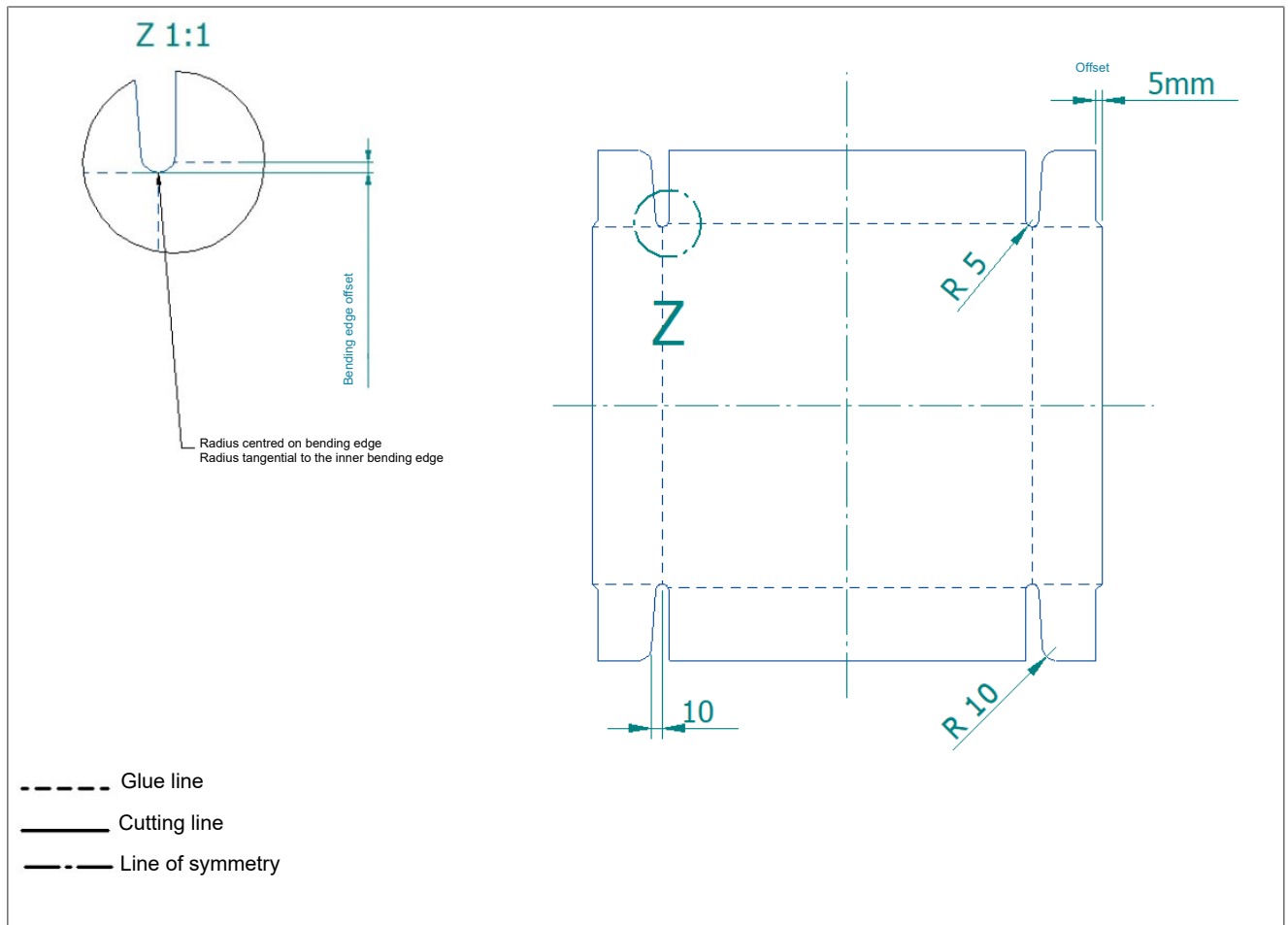

Fig. 79: Proposed drawing of tray

<p>Criteria required:</p>	<ul style="list-style-type: none"> <li>■ Minimum and maximum values compared to tray format area</li> <li>■ Easy bendability of gluing flaps</li> <li>■ Bending edge offset</li> <li>■ Tab height: min. 40 mm (Variopac); min. 55 mm (Varioline)</li> <li>■ Gluing flaps end at same height.</li> <li>■ Inclination of internal tab = 10 mm</li> <li>■ Slot width with bending edge = R5</li> <li>■ Depending on the variant, a gap is required (carton with cover flaps, basket, ...)</li> <li>■ Variopac: 1 mm all around</li> <li>■ Varioline: 5 mm all around</li> </ul>
<p>Optional criteria of Varioline:</p>	<ul style="list-style-type: none"> <li>■ Radius for the slots</li> <li>■ Slot radius tangential to inner bending edge</li> <li>■ Slot radius centred on bending edge</li> <li>■ Gluing flaps end at same height.</li> <li>■ Offset for gluing flaps (1x carton thickness)</li> </ul>



### 4.5 Proposal drawing of a tray (Variopac)

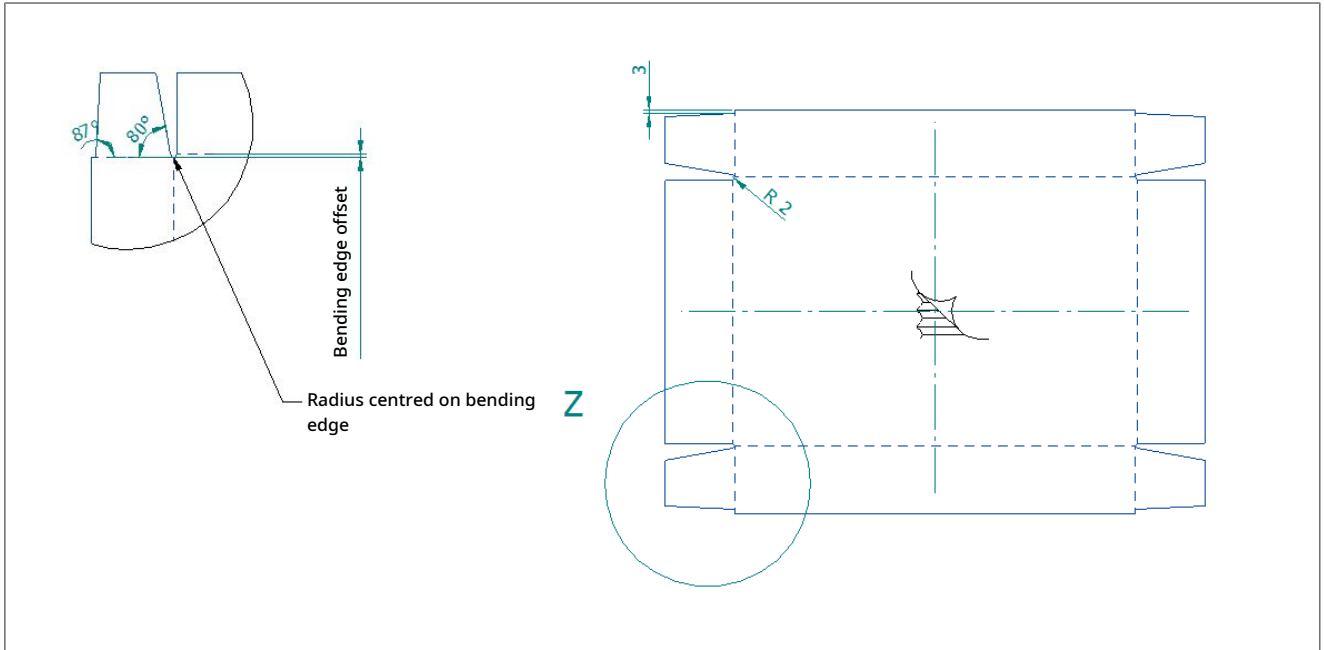

Fig. 80: Proposal drawing of a tray processed with a Variopac

### 4.6 Proposed drawing of Over-Top-Open (OTO)

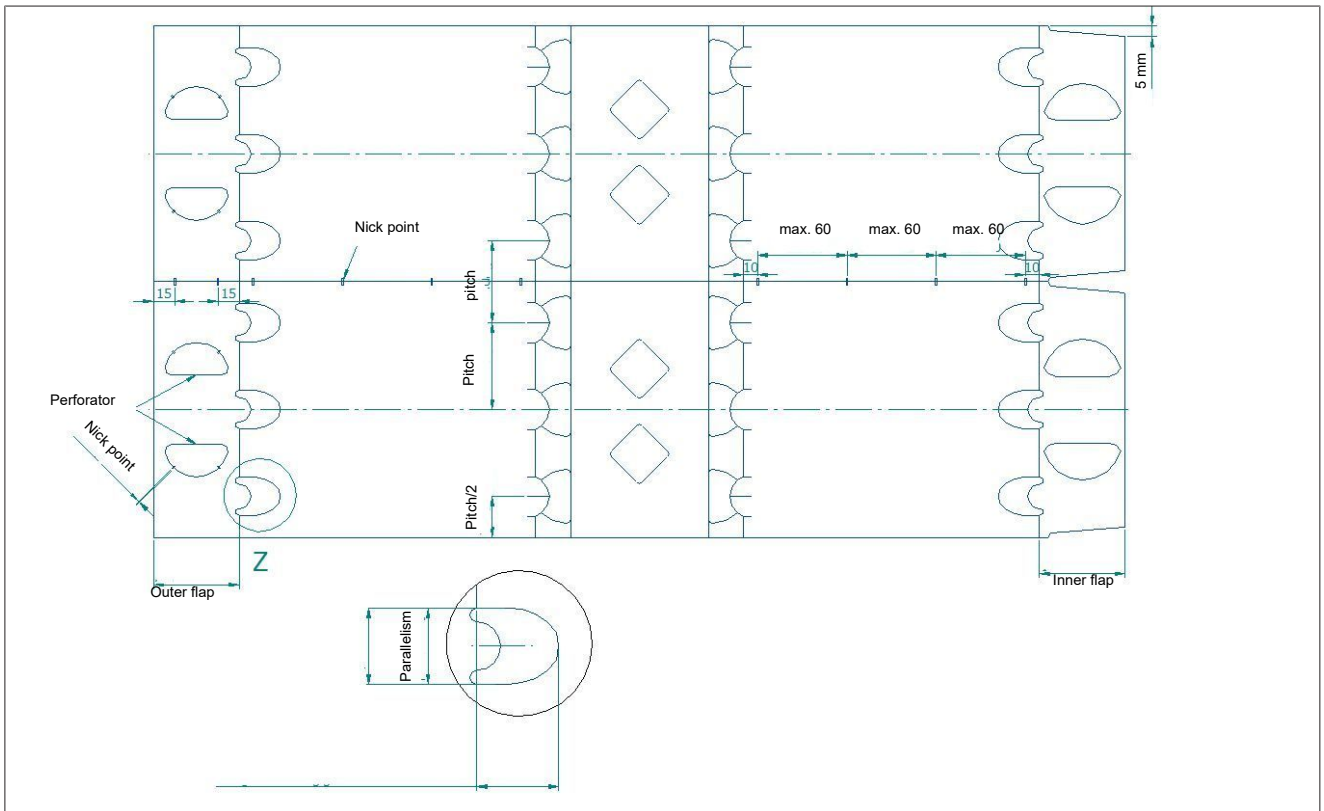

Fig. 81: Draft of over-top-open (OTO)



**Important**

Blanks must be checked and confirmed with bottles at Kronos!

<p>Criteria required:</p>	<ul style="list-style-type: none"> <li>■ Inside height = height of bottles in closed state</li> <li>■ OTO is closed at top</li> <li>■ Inner flap 5 mm shorter than outer flap</li> <li>■ Inner flap tapered (5mm)</li> <li>■ Inner flap handles &gt; outer flap handles (all around 3mm ±1mm)</li> <li>■ Inner flap handles and outer flap handles have the same shape</li> <li>■ Parallelism of cut-outs on bottle neck to centre the bottles</li> <li>■ Pitch = inner bottle diameter</li> <li>■ Permanently defined position of nick points for coherent blank</li> <li>■ Nick points may just be designed strong enough that the carton does not tear while being inserted into the magazine, but at the same time can easily be separated in closed condition.</li> </ul>
<p>Optional criteria of Varioline:</p>	<ul style="list-style-type: none"> <li>■ Products in Y-direction: Min. 1; max. 2</li> <li>■ Coherent blank -&gt; increased performance</li> <li>■ Cut-outs at the base for pin-partitioned crates or Ø17mm hole</li> <li>■ Inner flap handles punched</li> <li>■ Outer flap handles are perforated to the centre</li> </ul>

## 4.7 U-pad processing

When processing U-pads, the crease (R) and punch lines (S) must be executed as shown in the "U-pad" figure. It is important to note in this case that once the tabs have been erected by 90°, a self-holding function at 90° must also be guaranteed. It is essential that the U-pad is inspected by the Packaging and Palletising Technology Department at KRONES AG.

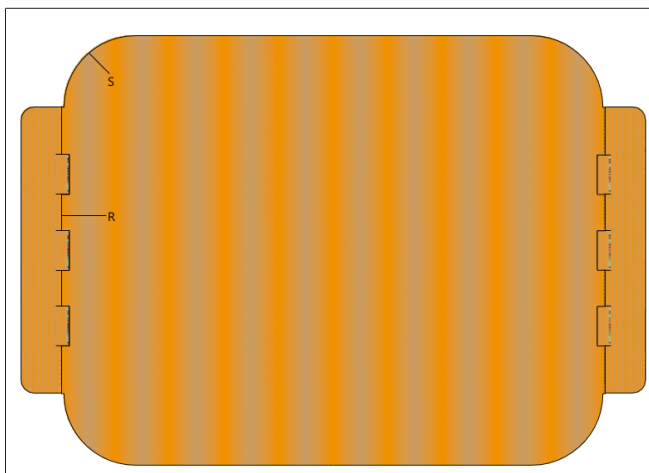

Fig. 82: U-pad (flat blank)

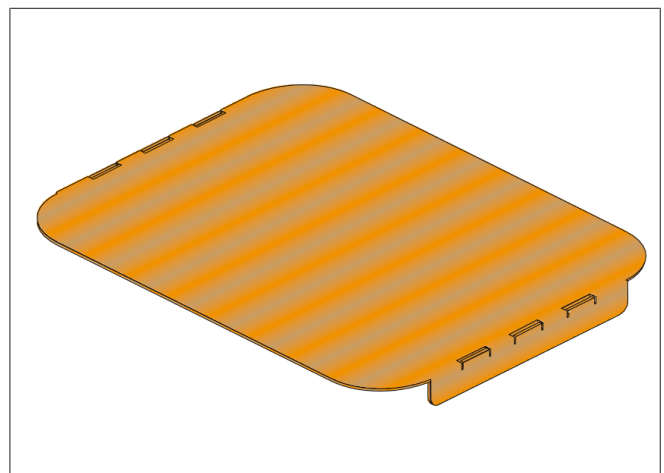

Fig. 83: U-pad (blank kinked)

S = Stamping line

R = Creasing line

## 5 Basket carrier

### 5.1 Field of application

In this specification the following packages (=blanks) are written and specified for processing on a KRONES packaging machine.



Fig. 84: Basket

Open basket carrier <<>> Open carrier, short flap on one side



Fig. 85: Basket

Closed basket carrier <<>> Closed carrier, short flap on one side  
Lid is a separate, loose blank

The actual function of the packaging function of the blanks and adherence to statutory requirements are the responsibility of the operator. The following points should be considered in this regard:

- Stability and carrying function for end user
- Transportability during manufacturing and distribution
- Pin mobility
- Identification capability (ink-jet, laser, ...)
- Tear-open and opening function
- The minimum shelf life of the gluing must extend over the periods of production, storage at the operator and storage at the end customer.

Due to the numerous combinations of materials basket designs, every type of packaging must be checked and released in its original form by KRONES AG. The final release will occur after commissioning. If the customer is not yet in possession of the packaging materials, KRONES AG issues recommendations (baskets, suppliers). Following a successful customer on-site acceptance inspection under taking production conditions, the packaging material used will be recorded, countersigned by both parties and defined as standard.

If changes are made to the material and packaging at a later time, the customer shall be responsible for informing KRONES AG and obtaining a release. Krones AG reserves the right to perform tests under conditions closely simulating production if changes are made to material or packaging by the customer. The resulting costs will be charged at usual market prices.

Nevertheless, under certain conditions, deviations from this specification are possible. For example, processing of baskets with lower grammages than those specified in the following is also possible, however this must only be developed using an additional function that must be developed for the specific customer.

As a result, baskets can be processed which deviate from the properties named in the following, whereby these must then be named individually and specifically in separate documents. In addition, tests must be performed in advance in the KRONES technical centre; the samples must be absolutely identical with the baskets to be processed in the order.

#### NOTICE

Non-specified deviations from this specification can result in limited performance and processability, even to the incapability to process.

## 5.2 Material specification

This chapter only deals with the individual specific material characteristics and their effects on workability. Individual specifications of material and the packaging design are not defined and must be agreed between the operator and the supplier.

Baskets are delivered pre-glued and are not erected until they are in the packer and are fixed by interlocking. For the Closed Basket Carrier variant, a cover is also applied after the container insertion, which then covers the container fully or partially.

### Grammage

The grammage of baskets is generally between 250 g/m<sup>2</sup> and 500 g/m<sup>2</sup>. Depending on the design, the basket can consist of one-piece or multi-piece blanks.

### Absorbency

The material used must not be porous, as otherwise the functions "separating" and "erecting" will be impaired. For this purpose, the meshing areas of the vacuum nozzles must be painted. Areas for later gluing (closed basket) must be executed without a top coat.

### Glue residues

The blanks must have the correct gluing and be free of glue residues. Gluing of the blanks in themselves and to each other must be avoided, as otherwise problems will result when pulling open.

## 5.3 Dimensional accuracy and processing

Adherence to the specified values is essential to ensure the packaging function and workability.

### Size tolerance for pre-glued "basket" blanks

Basic tolerance:	0.4 %	Material, climate, moisture
Production:	+ 0.6 mm	Stamping, bending

### Flatness

The blanks = baskets must lay on virtually flat and unbent in the loose state. For this purpose, a maximum deformation from the lowest to the highest point of 10 mm is permitted (see Figure).



Fig. 86: Baskets stacked



Fig. 87: Deformation

In addition, it must be ensured that baskets do not have excessively great deviations even when folded open. Therefore, the handles may have a maximum permissible deformation of 10 mm.



Fig. 88: Handle deformation

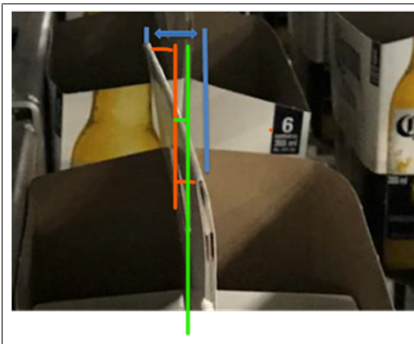

Fig. 89: Deformation with measurement



Fig. 90: Deformation through blank

Even though flat-lying baskets comply with the requirements, bad blanks may cause significant deformations during the erecting process and therefore result in non-workability. The KRONES AG is therefore not liable for faulty blanks and resulting production downtimes.

### One-sided interlock function

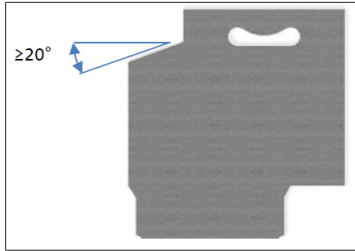

Fig. 91: Hooking in function

The basket must have at least one interlock which will prevent the basket from returning to the flat state.



### Distributing wedges



For reliable insertion of bottles at the ends, they must be provided with a distribution wedge  $\geq 20^\circ$ .

Fig. 92: Distributing wedges

### Tilt of the baskets and stacking height difference

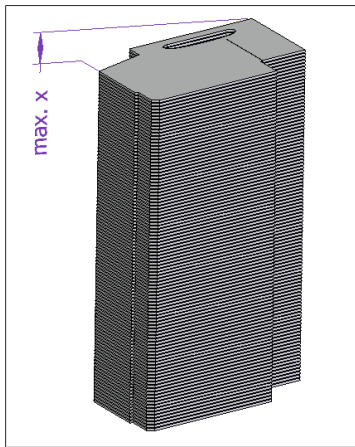

In principle, the baskets must be easy to stack in the flat blank.

The maximum basket tilt "x" must not exceed the values in the table below with loose stacking and light pressure on the top layer. In this case a distinction is also made between processing 6-packs and 4-packs.

Fig. 93: Baskets stacked

### Maximum basket tilt "x"

6-pack	100 mm
4-pack	70 mm

Also note that the stacking height difference depends on the basket tilt, as described below.

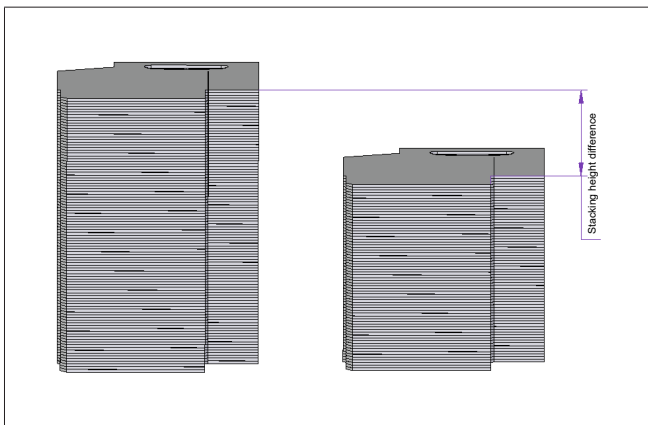

Fig. 94: Stacking height difference

Stacking height difference

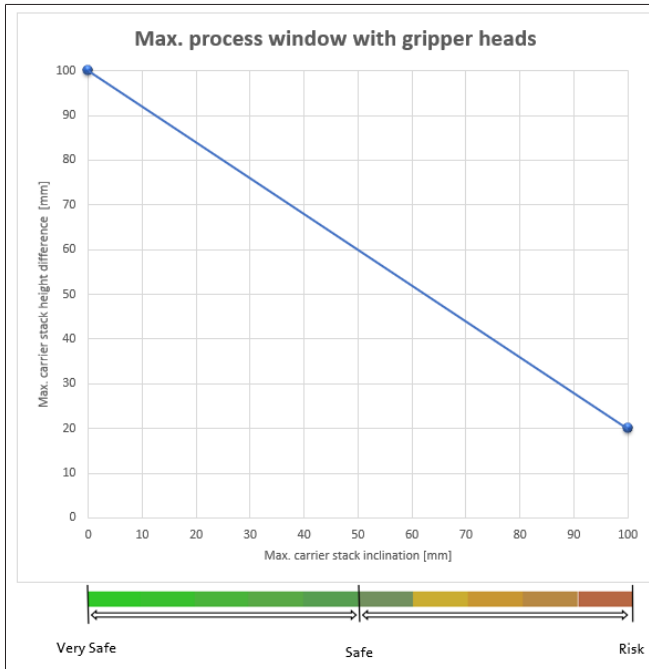

Fig. 95: Areas of the permitted stacking height difference depending on the basket tilt

The diagram below shows the areas of the permitted stacking height difference depending on the basket tilt. Areas are differentiated into those which guarantee a secure removal and those which pose a risk to removal.

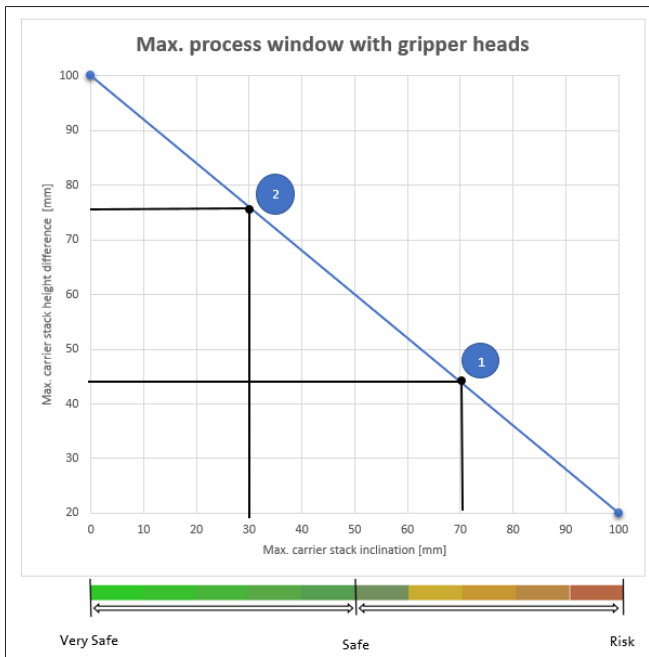

Fig. 96: Areas of the permitted stacking height difference depending on the basket tilt

### Example:

- Point 1:  
The stacking height difference in this point is 45 mm. Consequently, the maximum basket tilt must not exceed a value of 70 mm.
- Point 2:  
Conversely as in Point 1, the basket tilt in this case is used with approx. 30 mm as the reference value. This results in a permitted maximum stacking height difference of 75 mm.

A low basket tilt permits a higher stacking height difference!



## Cross bars and contour

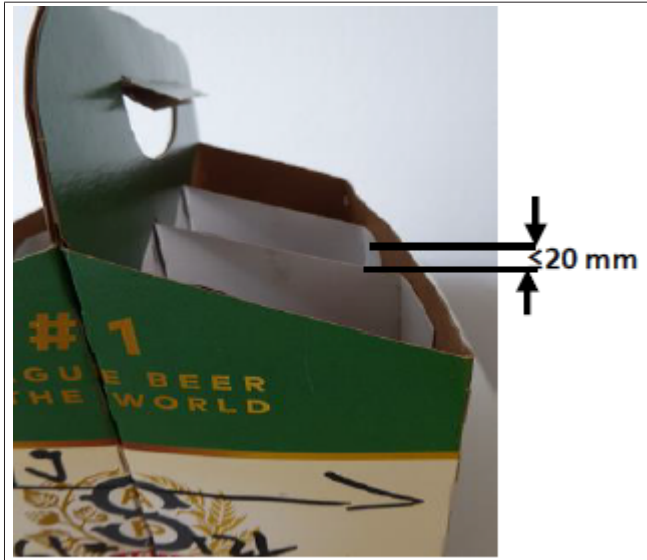

Fig. 97: Contour

The cross bars must not be further than 20 mm below the outer edge. In addition, the cross bars must also have a distributing wedge of  $\geq 20^\circ$ . If the outside contour does not run straight, the specialist department must be consulted.

### 5.3.1 Distances

In a basket, the bottles must have an all-around clearance from the transverse basket dividers of 0.25-1.5 mm. This distance is defined as:

**Nominal bottle diameter + distance = inside cell dimension**

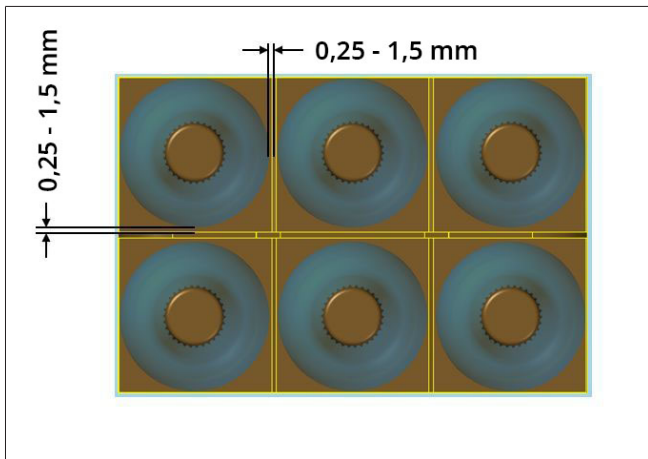

Fig. 98: Gap inside the basket

If it is not possible to meet this requirement, consult with the technical department.

## 5.4 Delivery and storage

The type of packaging and transport must protect the packs against damage or deformation. As regards delivery, appropriate agreements must be made between the supplier and user.

The following points must be met for proper processability of the blanks:

- The blanks must be freed of dust and punching residues.
- The stacked blanks must be easy to separate and must not get caught in the stack.
- The blanks must lie flat and must not become bent or deformed when transported.

- The orientation of the blanks in the transport pack must always be the same.

### Defined number per delivery pack

- Consistent number of baskets per delivery pack +/- 1 piece
- As a rule, the height of the baskets in an outer packaging must not exceed 480 mm when stacked loosely with light pressure to the top layer.  
Important: The actual height for the respective order must be clarified individually with the technical department.

### Moisture

- The moisture content of the material on delivery affects the processability. The set-point value on delivery is 5 - 8 %. This can be measured using a rod hygrometer.

### Outer packaging



Fig. 99: Packaging

- It must be possible to open the outer packaging on the flat side of the basket or it must be delivered without lids.
- As the result of a carton open at the top, each pack can be directly emptied into the magazine shaft. The magazine shafts must be loaded uniformly.
- In the event of any deviations in the outer packaging, it is absolutely essential that the specialist department be consulted in order to point out possible problems.

## 5.5 Storage

The climatic conditions during storage can negatively impair the flatness, the dimensional accuracy and the processability.

### Storage recommendations

- Storage duration: Glued blanks = baskets 6 months
- Storage climate: 18 – 22 °C at 50 % – 70 % rel. humidity
- max. 25 °C storage of pallet in wrapped or shrunk state
- No direct exposure to sunlight or heat

### Preparations for processing

- The opening of the original packaging should take place shortly before blank processing.



## Basket carrier

- Under damp processing conditions, the film around the pallet must not be removed until shortly before processing.
- Partial quantities must be repackaged moisture-proof prior to storing.



## 6 Specification of dividers

### 6.1 Palletising and storage

The dividers should be bundled and placed onto a pallet in multiple layers. A layer pad must be inserted between each layer. An additional protective film (e.g. shrink hood) protects the dividers from environmental and ambient influences, e.g. moisture and dirt. Any application of weight on the dividers must be avoided during storage as this could permanently deform the dividers. Loose dividers must be stored horizontally.

The maximum storage period for the above-mentioned packaging type should not exceed nine months. The properties of unprotected dividers may change significantly due to the absorption of moisture. This may result in processing problems (e.g. divider cardboard containers which are curved significantly upwards due to moisture).

Cardboard containers should never be exposed to direct sunlight.

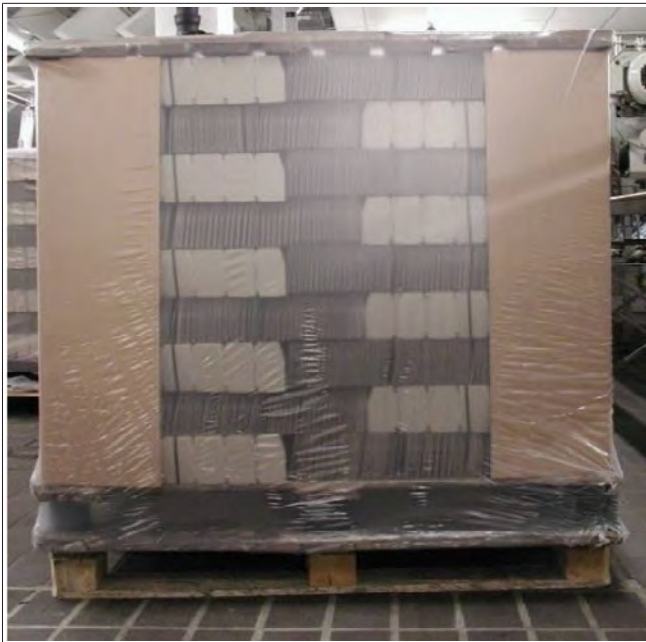

Fig. 100: Palletising

### 6.2 Usable materials

Preferably E-flute or solid board



Fig. 101:

Flute pitch t	2.6 – 3.5 mm
Flute height h	1.0 – 1.9 mm
Flutes per m	286 – 385 1/m

### 6.2.1 Examples of corrugated board and solid board dividers

E-flute and B-flute



Fig. 102:



Fig. 103: Solid board

#### NOTICE

The dividers delivered for production must be inserted according to the "German bundle layer". This refers to the situation where the horizontal struts (perpendicular to the running direction) are folded to the right for upright slots.

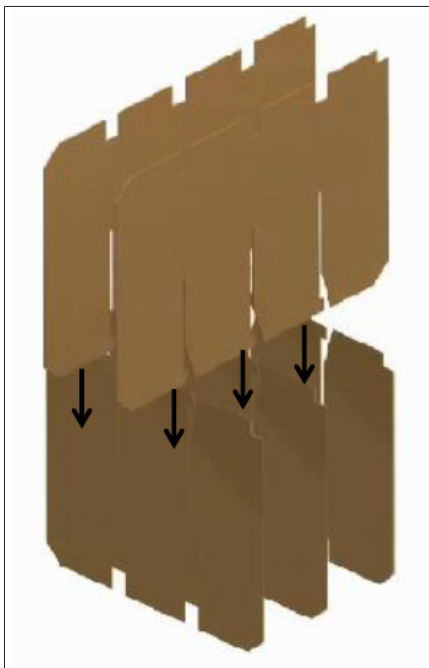

Fig. 104: Plug-in direction

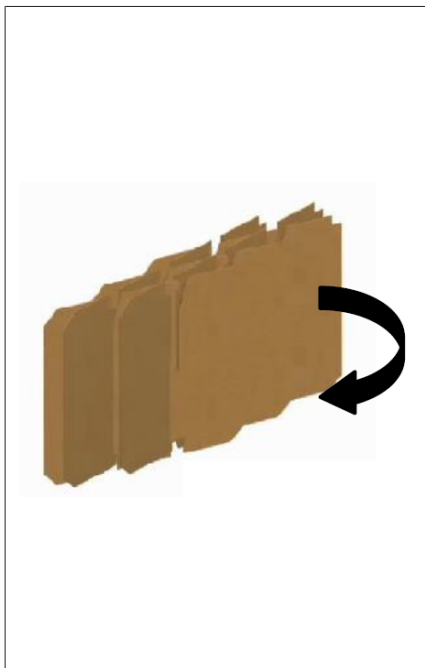

Fig. 105: Erecting direction Fold-open direction clockwise

### 6.3 Erecting process

The "4x3" formation requires three horizontal and two vertical struts. In this case, all vertical and horizontal struts are suctioned and erected by the movement of the grippers.

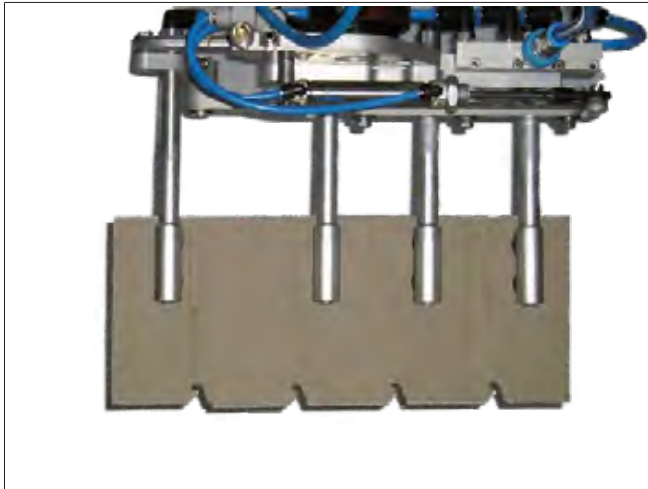

Fig. 106: Erecting process



Fig. 107:

## 6.4 Requirements for a divider

### Divider calculation formulas

$Z1 = \text{nominal container diameter} + x + 1 \text{ mm}$

$Z2 = Z1 - 4 \text{ mm}$

H = maximum container height

X = material thickness

S = X + 2 mm to 4mm for corrugated cardboard

X + 1 mm to 2 mm for solid board

### Longitudinal panel used with Variopac

To avoid erecting errors, the edge strut must be at least 4 mm shorter than the cell dimension.

->  $Z2 = Z1 - 4 \text{ mm}$

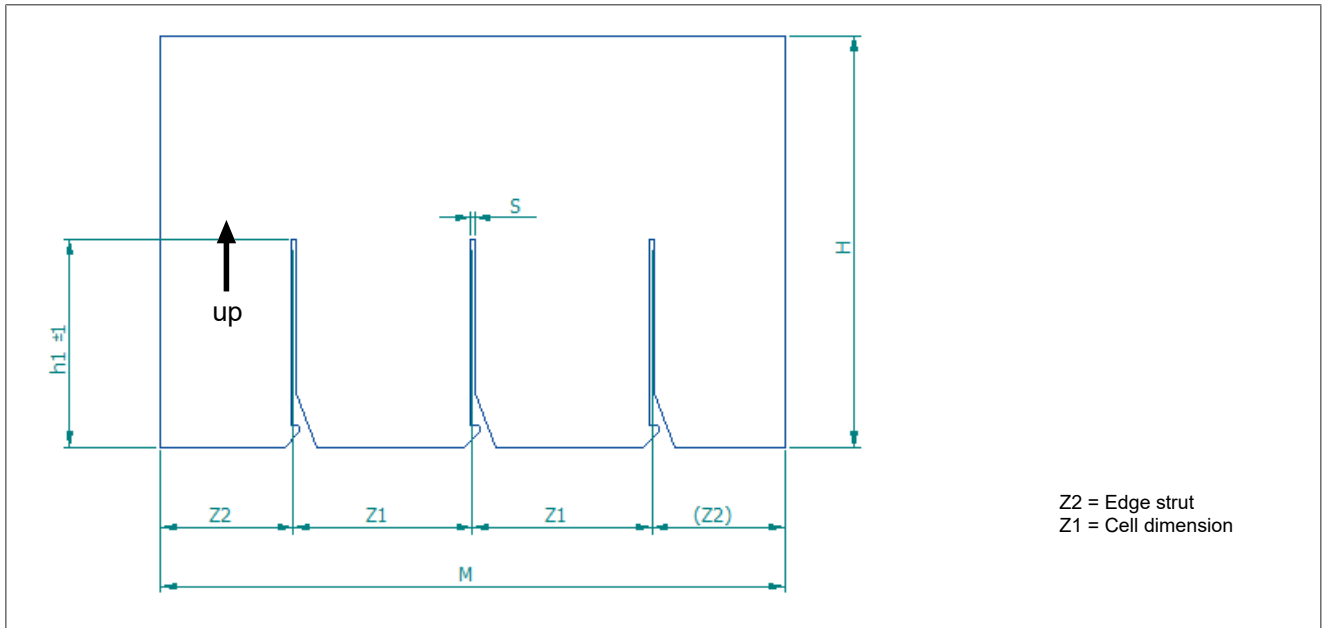

Fig. 108: Longitudinal panel used with Variopac

### Transverse panel used with Variopac

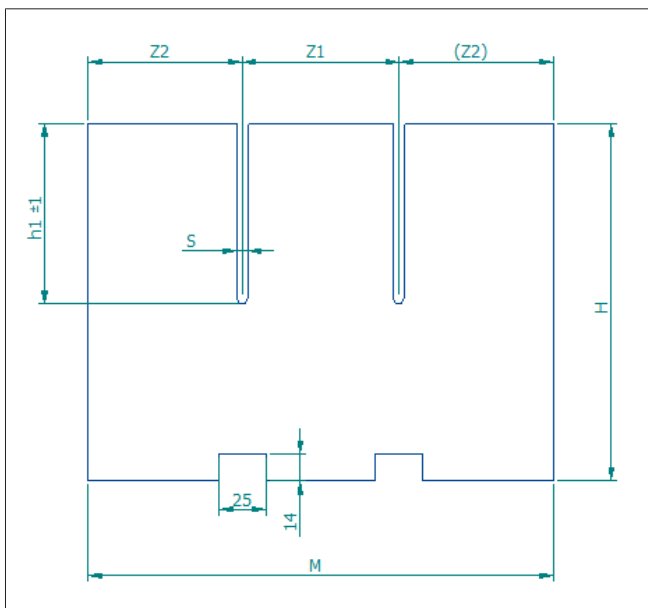

Fig. 109: Transverse panel used with Variopac

## Longitudinal and transverse panel used with Varioline

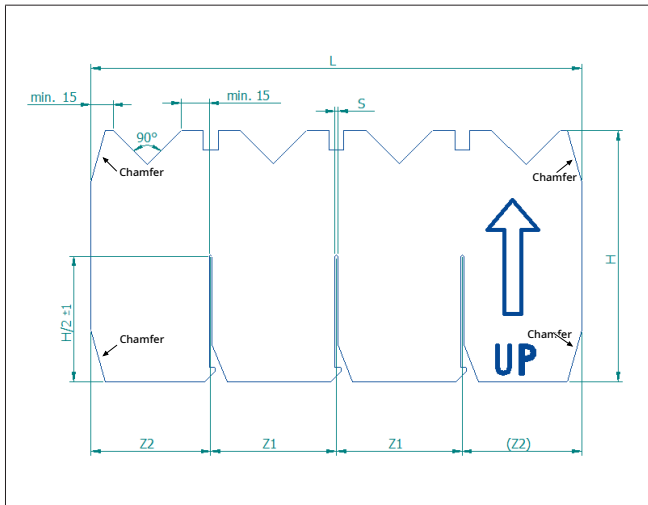

Fig. 110: Longitudinal panel used with Varioline

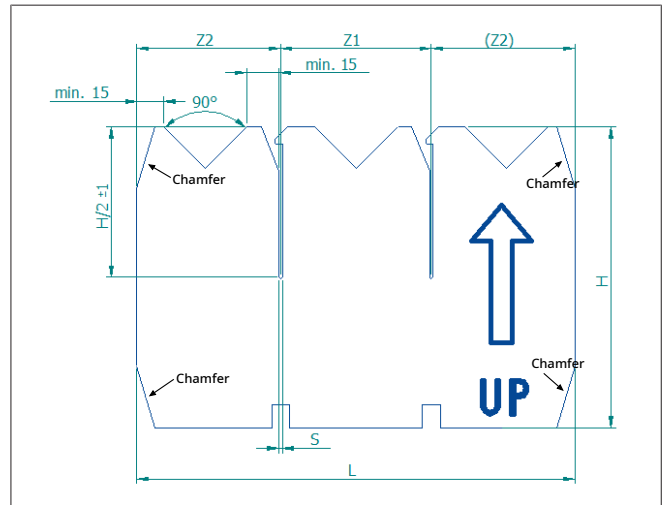

Fig. 111: Transverse panel used with Varioline

### Criteria required:

- Marking on the top side

### Scope of application: Solid board and corrugated cardboard

- Interlocking required
- Divider height: Min. shoulder height; max. product height
- Edge struts: min. 4 mm shorter than pitch; max. 10 mm
- min. 2x3 dividers, smaller is special case (Variopac)
- Fold-open direction clockwise
- Plug-in direction: Short bars at bottom

### Additional criteria for Variopac:

- The minimum length of the outer segments is 45 mm and their maximum length is half the bottle diameter +5 to 10 mm
- B-flute dividers for 6x4 formations or larger are difficult to handle -> consult with the technical department
- Divider height: min. 80mm/max. 350mm
- Length of knocked down divider: min. 180mm/max. 560mm

### Additional criteria of Varioline:

- 2x3 dividers is a special case (consultation required)
- Chamfering at all edges to prevent them from catching
- The forming of the chamfers depends on the carton size -> consultation with the specialist department required



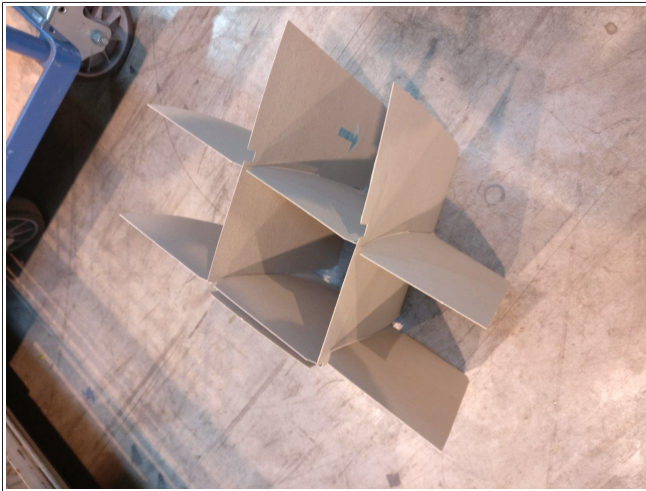

Example of a special solution for a 2x3 divider (A-divider, Varioline)

Fig. 112: A-divider

### 6.4.1 Tolerances

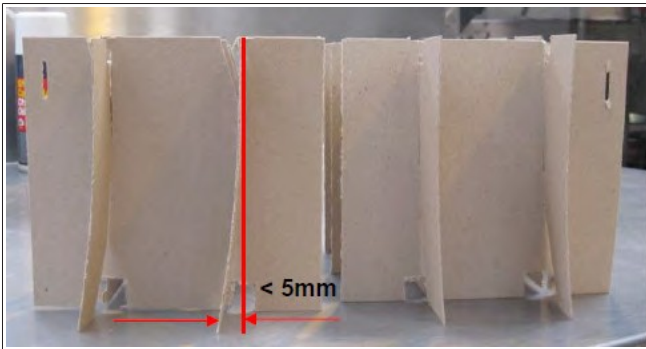

Deformation or torsion of less than 5 mm across the divider height is tolerable.

Fig. 113: Bending



A distortion of maximum 50 mm can be tolerated on the total stacking height.

Fig. 114: Stack height

These tolerances apply to solid and corrugated cardboard.

### 6.4.2 Distances

Within one divider a gap of 0.5 mm all around is required from the container to the divider bars. This distance is defined as:



**Nominal bottle diameter + 1 mm = Inside cell dimension**

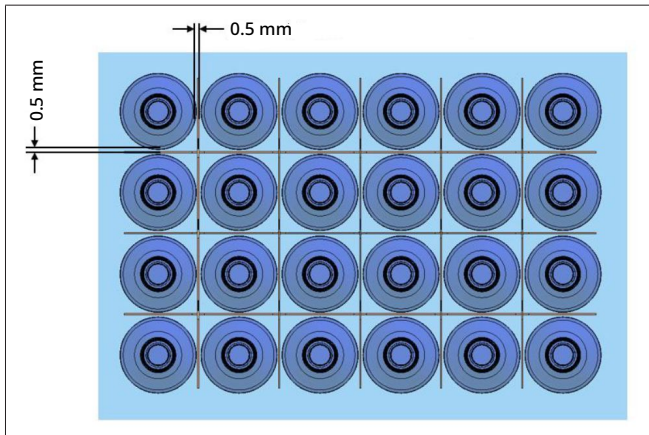









Fig. 115: Distances



## 7 Cardboard clips for cans

### 7.1 Basic shapes for beverage cans

#### Overview of pack types

Can pack types	Pack formation	Standard 	Standard 	Sleek 		Slim 
<b>Can lid type</b>		202	202	200	202	200
<b>Volume</b>		+/- 330 ml	+/- 500 ml	max. 355 ml		max. 250 ml
<b>LitePac Top</b> 	2x2	●	●	●	●	●
	2x3	●	●	●	●	●
	2x4	●	●	●	●	●
<b>LitePac Top Promo Skirt</b> 	2x2	●	●	●	●	●
	2x3	●	●	●	●	●
	2x4	●	●	●	●	●
<b>LitePac Top Protect</b> 	2x2	●	●	●	●	●
	2x3	●	●	●	●	●
	2x4	●	●	●	●	●



## 7.2 Specifications

### 7.2.1 Basic dimensions clip

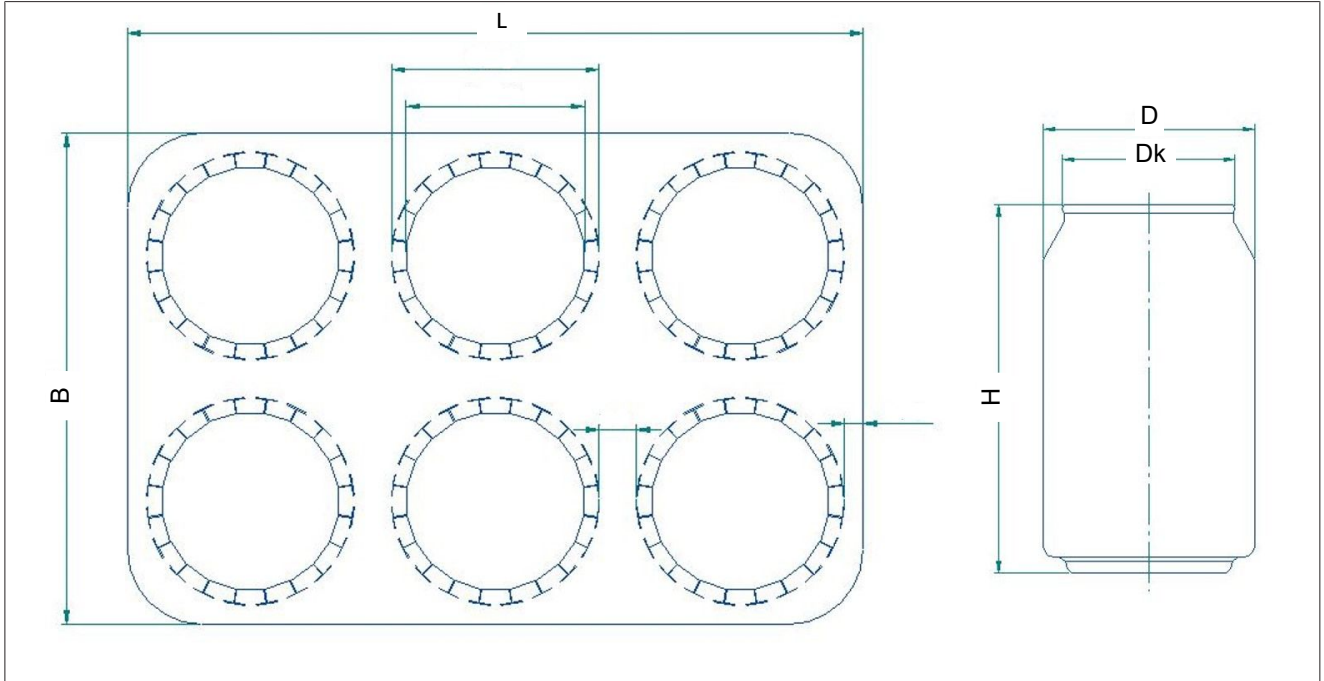

Fig. 116: Basic dimensions

$$L \leq D \times n$$

$$B \leq D \times n$$

- D: Outer can diameter
- Dk: Can head diameter
- H: Can height
- n: Number of cans in a row

### 7.2.2 Specifications for Basic Dimensions

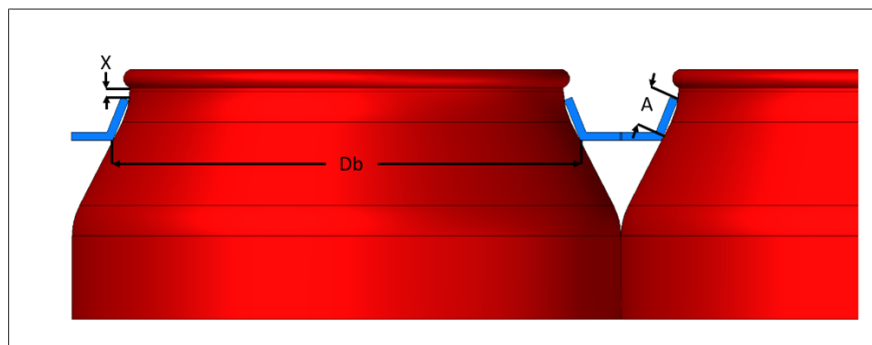

- D<sub>b</sub>: Diameter of bending grooving
- A: Flap length
- X: Distance between crimping edge and tab

Fig. 117: Basic dimensions of cardboard clip

The tab length A must be selected so that for the distance X between the crimping edge and the tab the following applies:  $x \geq 1.5 \text{ mm}$



## Cardboard clips for cans

### 7.2.3 Pick-up surfaces

#### Pick-up surfaces on 4-container cardboard clip

##### Individual cardboard clip

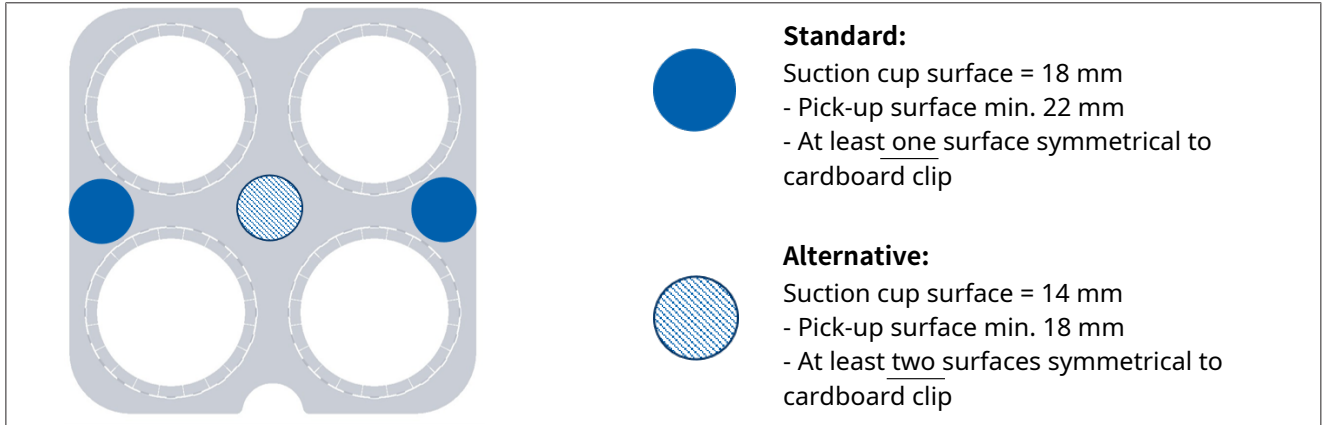

Fig. 118: Example: 4-container cardboard clip, individual

##### Connected cardboard clips (via microjoints)

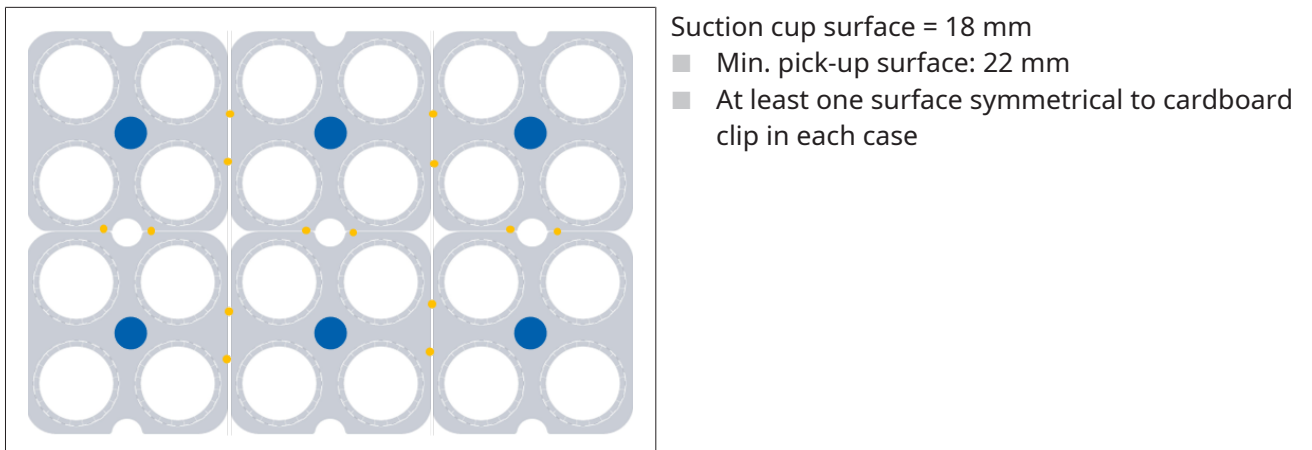

Fig. 119: Example: 4-container cardboard clip, connected via microjoints (yellow)



### Pick-up surfaces on 6-container cardboard clip

#### Individual cardboard clip

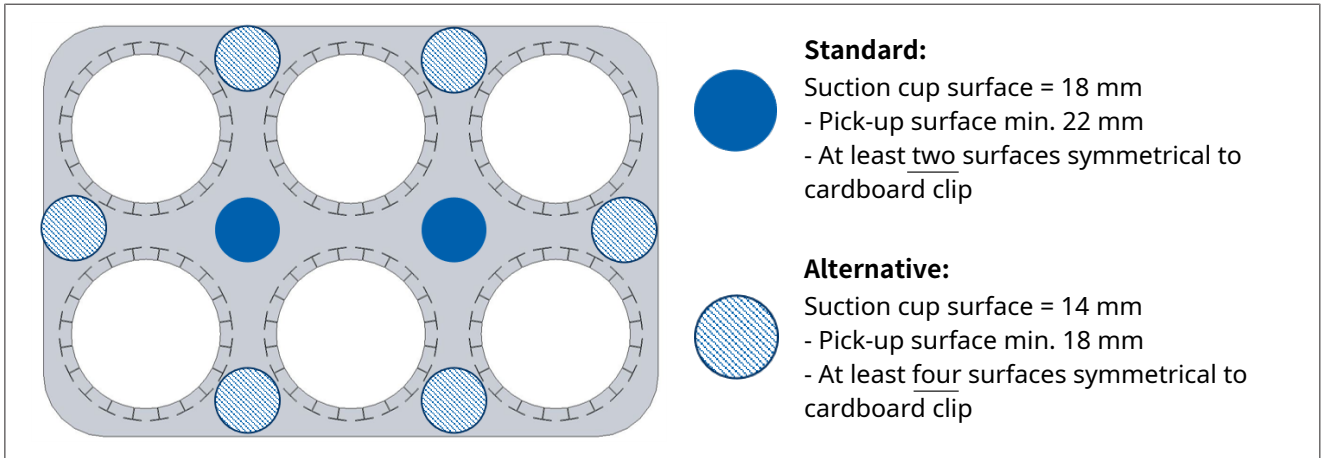

Fig. 120: Example: 6-container cardboard clip, individual

#### Connected cardboard clips (via microjoints)

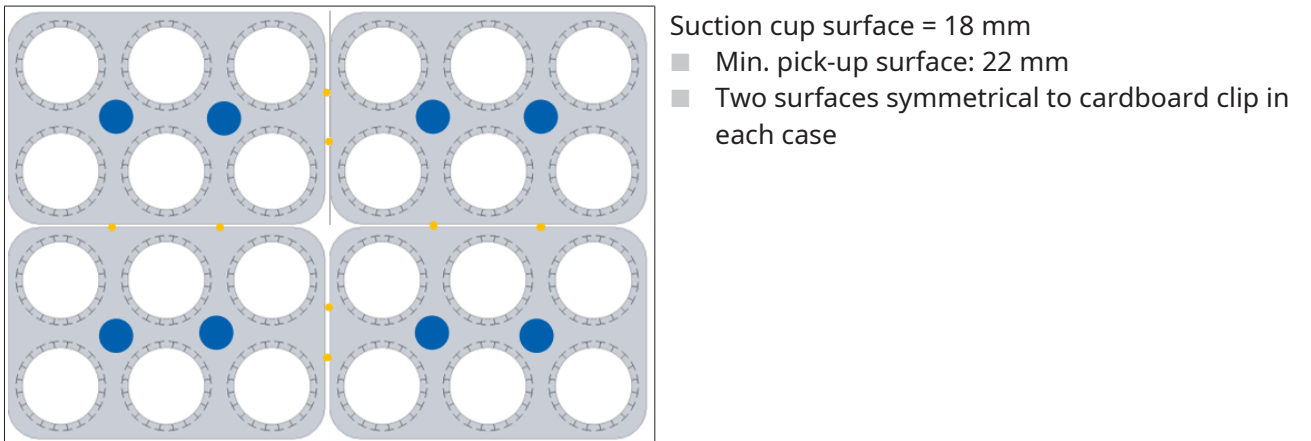

Fig. 121: Example: 6-container cardboard clips, connected via microjoints (yellow)



### Pick-up surfaces on 8-container cardboard clip

#### Individual cardboard clip

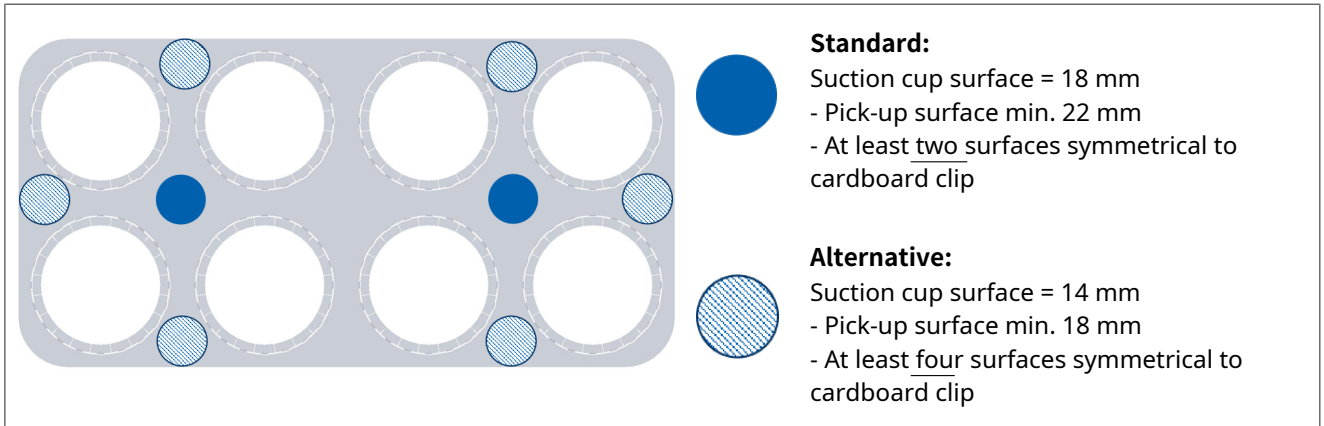

Fig. 122: Example: 8-container cardboard clip, individual

#### Connected cardboard clips (via microjoints)

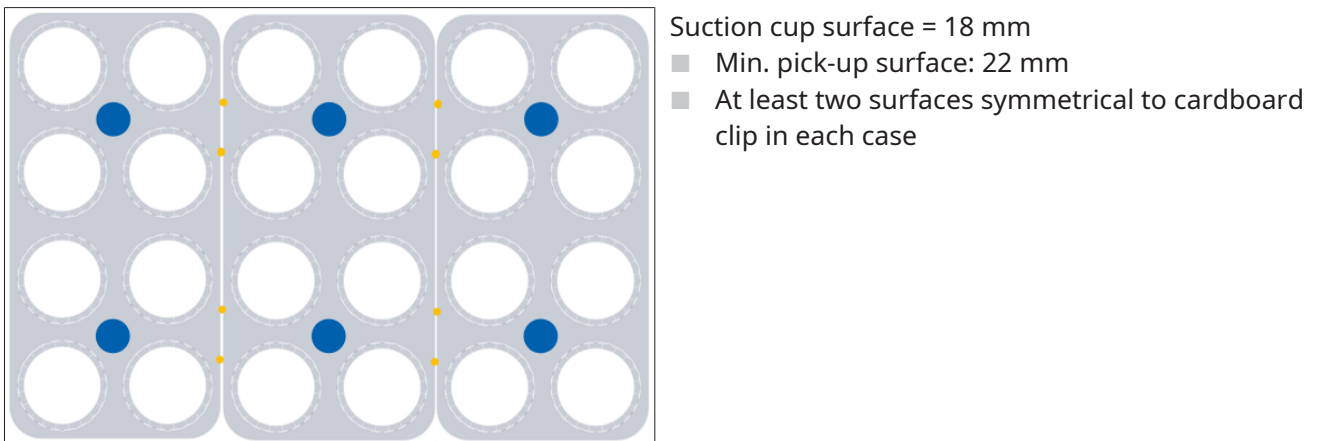

Fig. 123: Example: 8-container cardboard clip, connected via microjoints (yellow)

### 7.2.4 Handle holes

The following specifications apply to the cardboard clip handle holes:

- Minimum diameter of the handle holes of 20 mm
- Handle holes not open but closed
- Handle holes cover secured with microjoints of at least 0.5 mm

Sucking-on with a suction cup of  $\varnothing$  15 mm must be ensured.

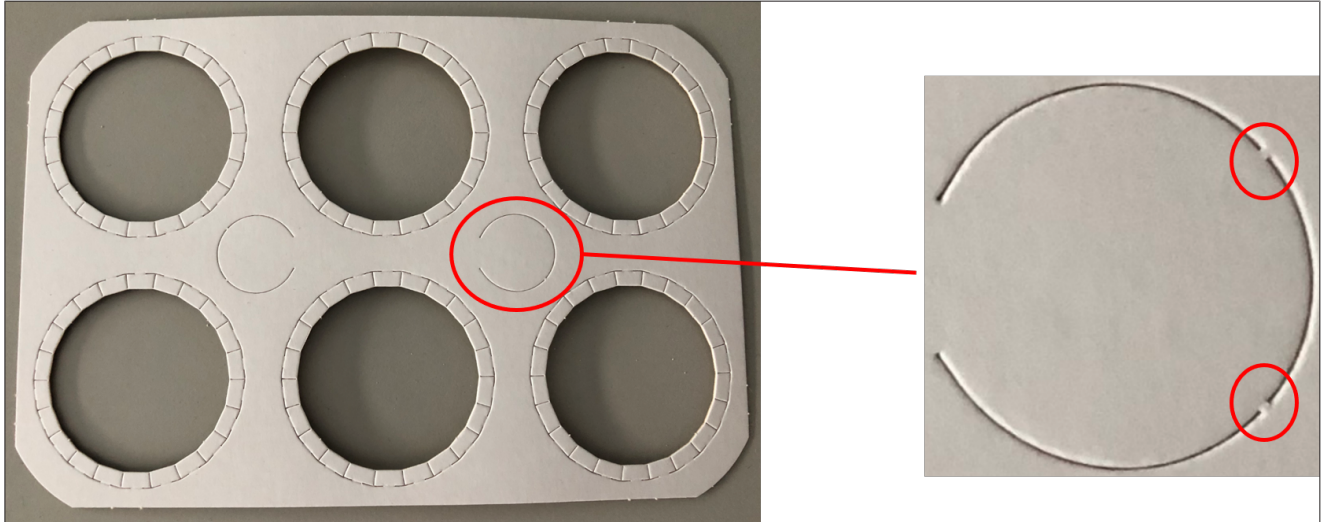

Fig. 124: Handle holes on cardboard clip

### 7.2.5 Permissible press-on forces - Varioline

Admissible pressing-on force determined via pressure test (flat blank):

- 4-container pack  $\rightarrow$  max. 200 N/pack
- 6-container pack  $\rightarrow$  max. 300 N/pack
- 8-container pack  $\rightarrow$  max. 400 N/pack

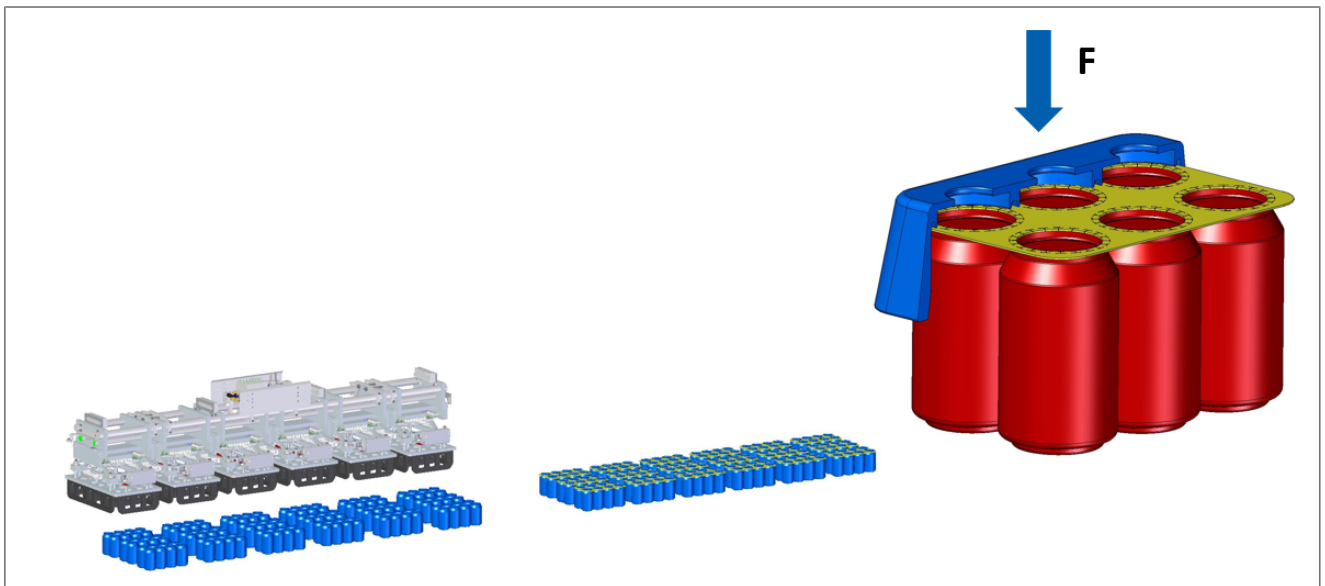

Fig. 125: Permissible press-on forces - Varioline



### 7.2.6 Permissible press-on forces - Variopac

Admissible pressing-on force determined via pressure test (flat blank):

- 4-container pack → max. 200 N/pack
- 6-container pack → max. 300 N/pack
- 8-container pack → max. 400 N/pack

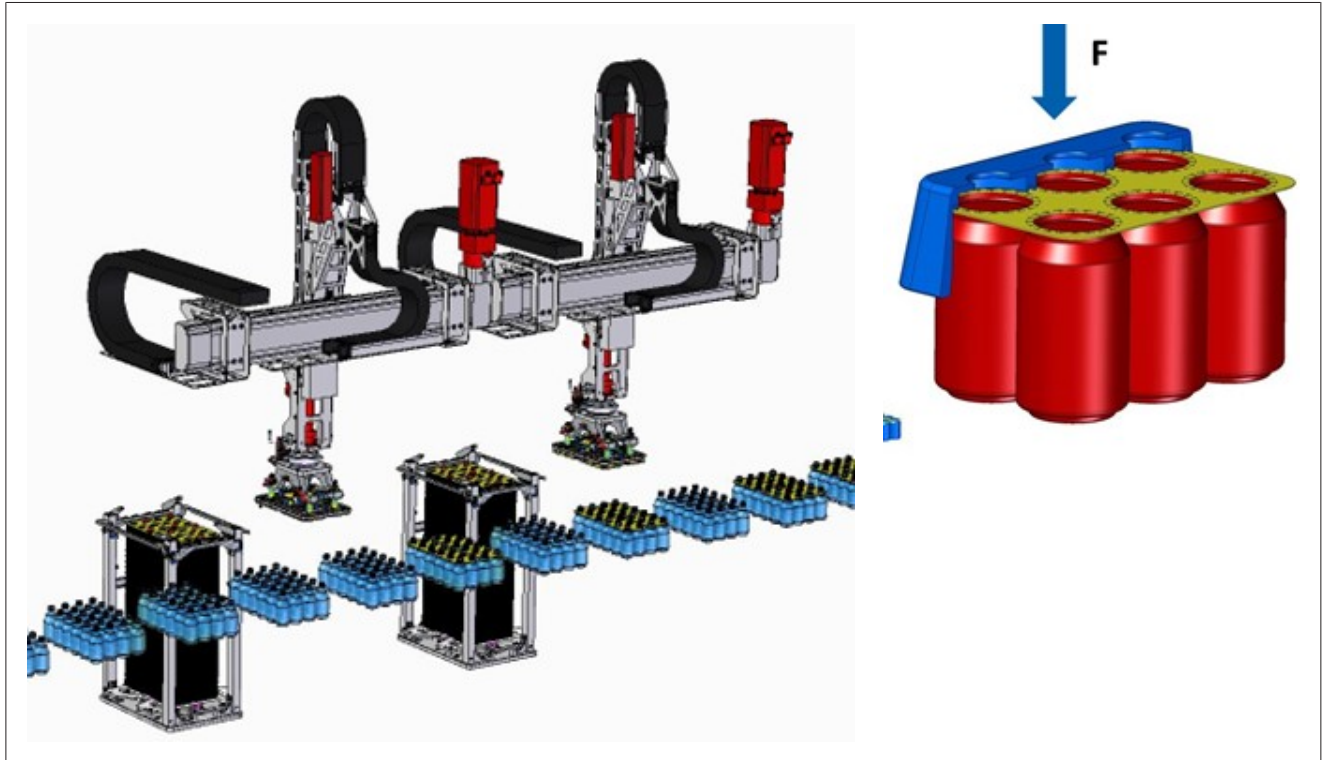

Fig. 126: Permissible press-on forces - Variopac

## 7.3 Recommendations for carton design

Surface weight (grammage) depending on the pack dimensions:

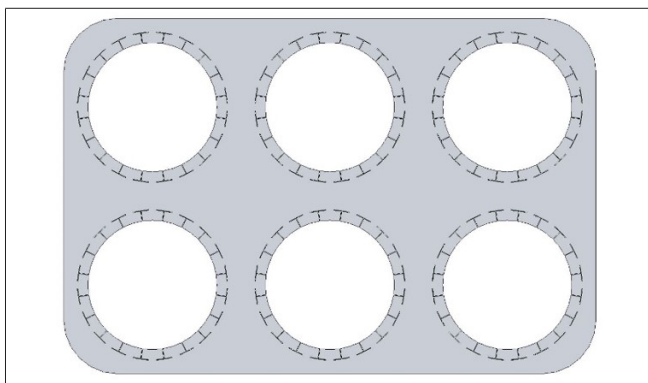

Fig. 127: Carton design

- 4-container pack x 330 ml → 405 g/m<sup>2</sup> → 3.45 g/pack
- 4-container pack x 500ml → 425 g/m<sup>2</sup> → 3.62 g/pack
- 6-container pack x 330 ml → 425 g/m<sup>2</sup> → 6.08 g/pack
- 6-container pack x 500ml → 450 g/m<sup>2</sup> → 6.44 g/pack
- 8-container pack x 330 ml → 480 g/m<sup>2</sup> → 9.10 g/pack
- 8-container pack x 500ml → 480 g/m<sup>2</sup> → 9.10 g/pack



## 8 Cardboard clips for bottles

### 8.1 Varioline

#### 8.1.1 Design of the cut-outs

##### Execution of perforation for crown

To protect the bottles from falling out, a star-shaped cut-out is required on the top side of the carton. This must be designed so that the carton is pushed over the crown and hooks in under the crown (marked in red) when the carton is pressed onto the bottle.



Fig. 128: 4-pack



Fig. 129: 6-pack

To achieve a clean processing result, it is necessary that the star-shaped cut-outs have are arranged suitably. In the illustration below, the left-hand side shows the development of an unwanted weak point, as the cut-outs run parallel to the axes resulting during pressing on (red lines). If the arrangement is turned (right-hand illustration), parallel running to the axes can be avoided.

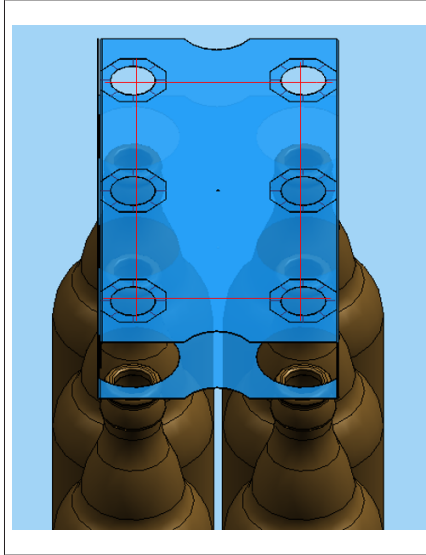

Fig. 130: Cut-outs parallel to the axes (red lines)

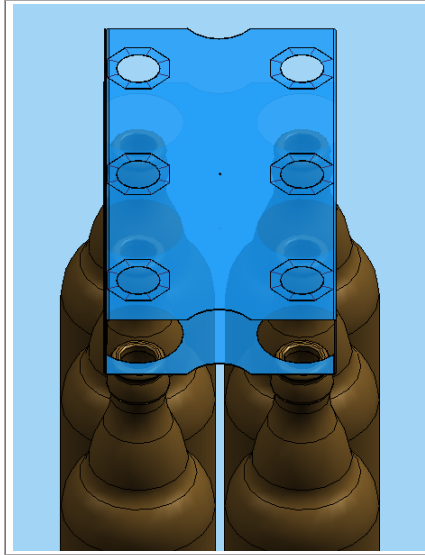

Fig. 131: Cut-outs not parallel to the axes

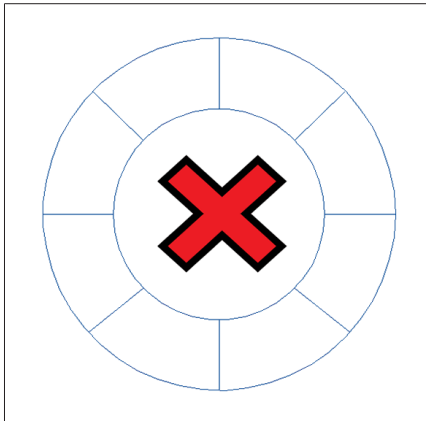

Fig. 132: Incorrect alignment

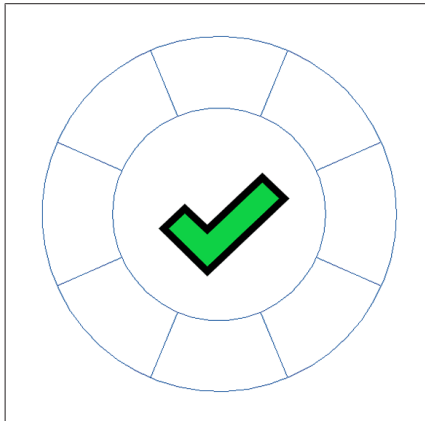

Fig. 133: Correct alignment



### Design of the cut-outs for the bottle neck

When the clip is put on, it is pressed further down below the crown to ensure that it securely locks under the crown. To achieve this, the diameter of the bottle neck must not collide with the bottom cut-out of the clip (area circled in red).

□When the cardboard is 5 mm below the crown, the diameter of the cut-out must be at least as large as the bottle neck diameter in this position.

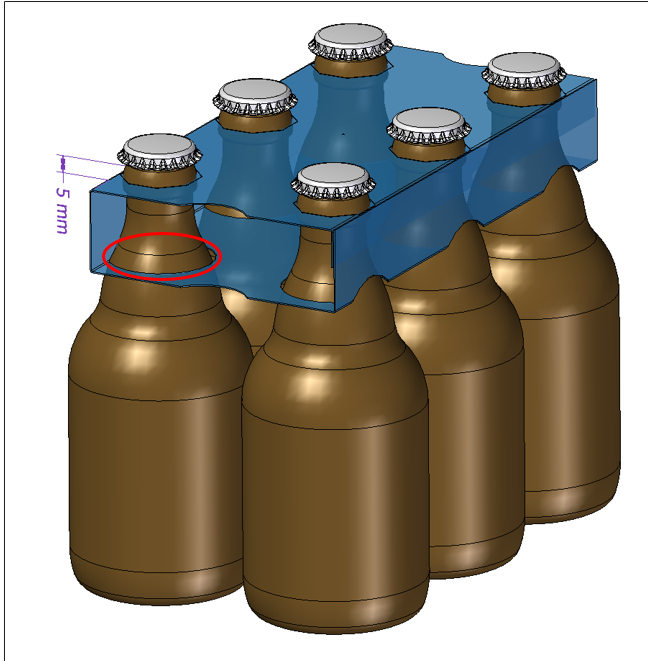

Fig. 134: Putting on the clip

### 8.1.2 Pick-up surfaces

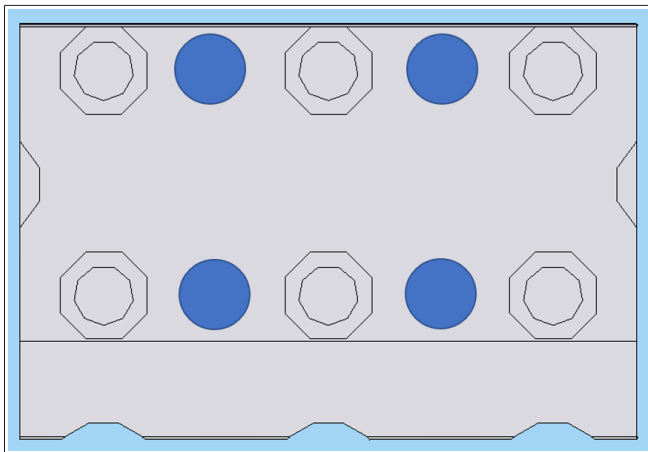
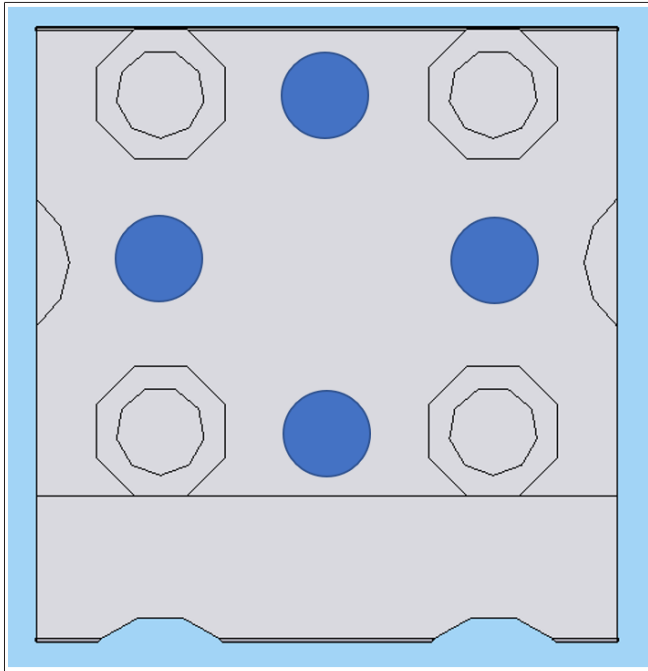

Fig. 135: Pick-up surfaces of 6-pack



## Cardboard clips for bottles



*Fig. 136:* Pick-up surfaces of 4-pack

Blue: Required suction surface

### 8.1.3 Tilt and stacking height difference

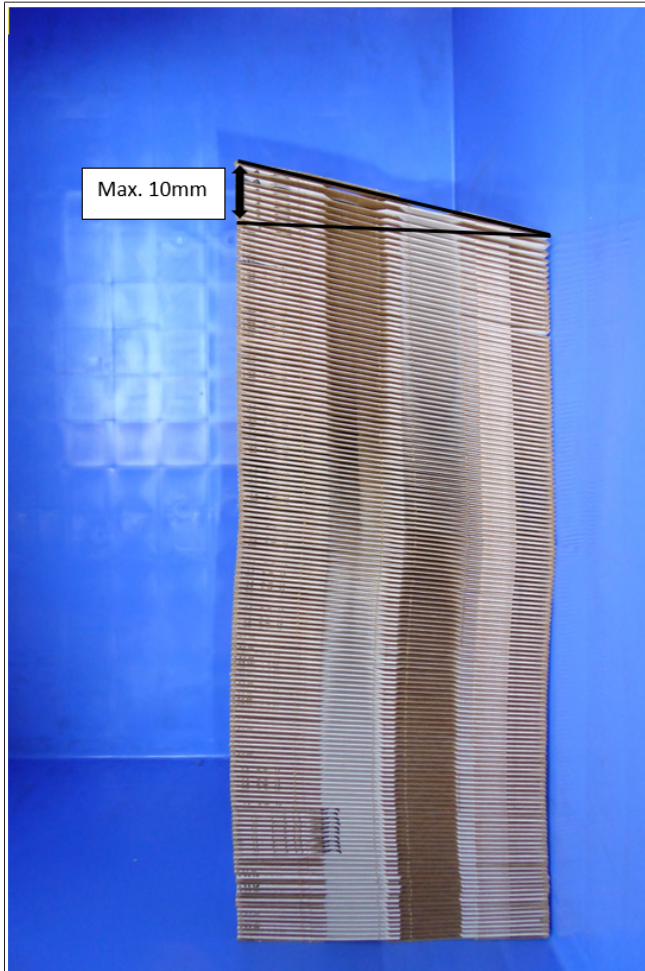

Before on-top clips are placed on the bottles, they must be removed from a so-called "magazine". Here it is decisive that the clips are removed mostly straight on at the same height.

A tilt of **10 mm** may never be exceeded.

Fig. 137: Tilt and stacking height difference

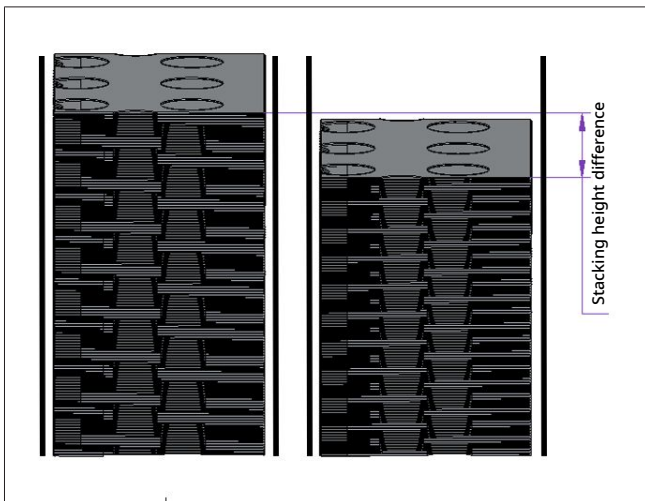

In addition to the inclined position, the smallest possible stacking height difference must be produced. To ensure removal, the difference may be a maximum of **40 mm**.

#### NOTICE

The tilt and stacking height difference are closely related to each other and influence each other.

Fig. 138: Stacking height difference



Fig. 139: Areas of permitted stacking height difference depending on tilt

The diagram below shows the areas of the permitted stacking height difference depending on the tilt. Areas are differentiated into those which guarantee a secure removal and those which pose a risk to removal.

### Example:

- Point 1:  
The stacking height difference in this point is 33 mm. Consequently, the carton tilt must not exceed a value of 7 mm.
- Point 2:  
In contrast to Point 1, the tilt in this case is used with approx. 3 mm as the reference value. This results in a permitted maximum stacking height difference of 37 mm.

### NOTICE

A low tilt permits a higher stacking height difference!

## 8.1.4 Permissible forces when removing and pressing on for 4 and 6 -packs

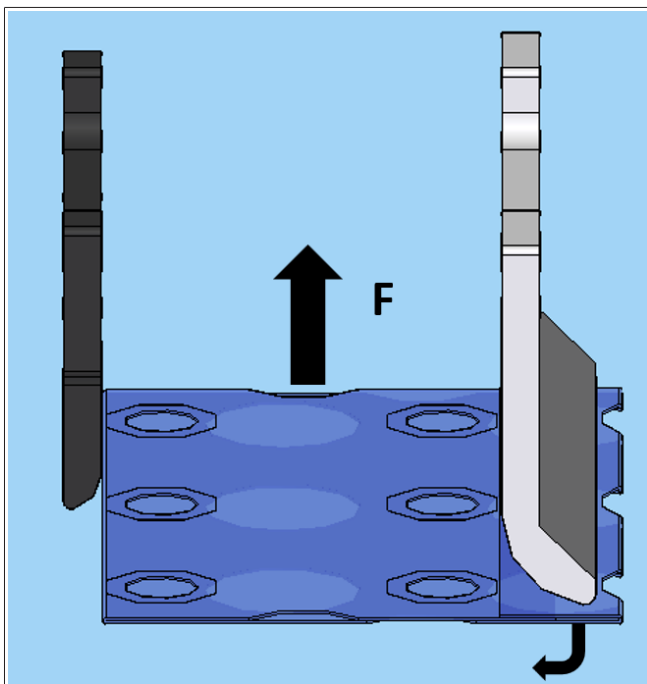

Fig. 140:

### Removal:

To overcome the resistance forces of the carton which result during removal and folding open, the required force of  $F=25\text{N}/\text{pack}$  must not be exceeded.

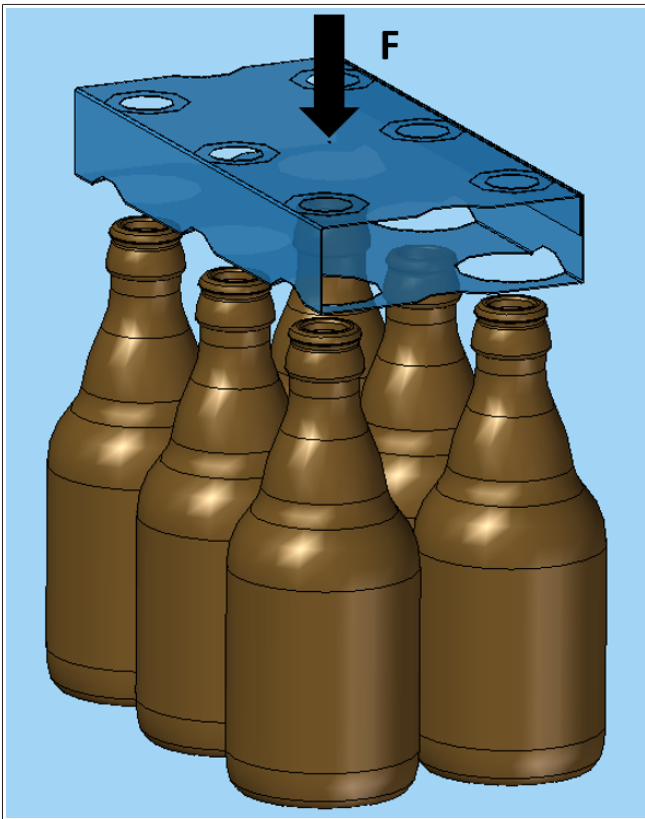

Fig. 141:

**Placement**

The required press-on force must not exceed a value of 140N/pack.





## 8.2 Variopac

### 8.2.1 Specifications for single-piece packaging

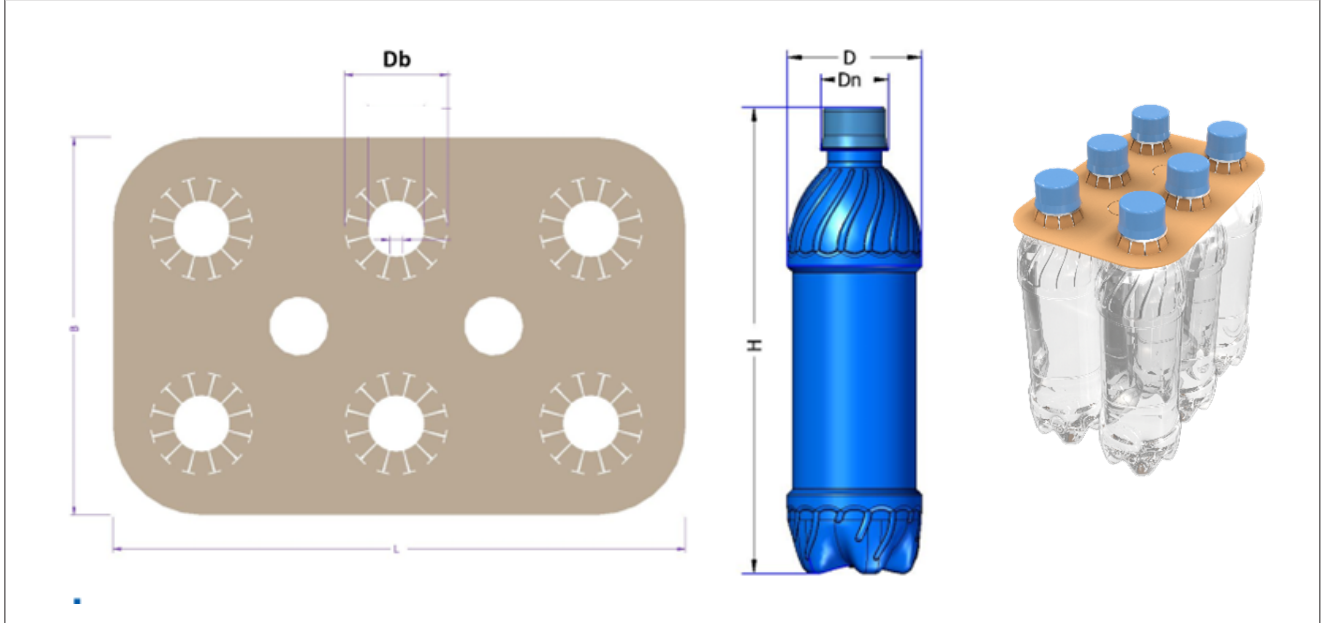

Fig. 142: Dimensions of clip

#### Dimensions:

$$L \leq D \times n$$

$$B \leq D \times n$$

$$Db \geq Dn + 4$$

- L: Length of clip
- B: Width of clip
- D: Outer diameter of bottle
- Dn: Neck ring diameter
- Db: Diameter of bending grooving

The outer dimensions of the clip must not exceed the outer dimensions of the container.

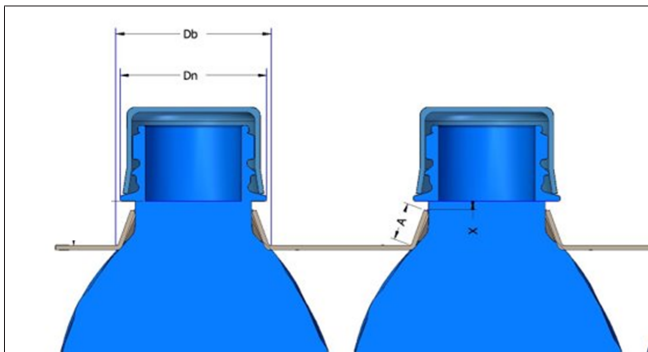

Fig. 143: Flaps of the of the star-shaped cut-out

- X: Required application tolerance  $\geq 4$  mm
- A: Length of the flaps
- Db: Diameter of bending grooving

The length of the flaps A must be selected so that the application tolerance of at least 3 mm is kept if the clip rests on the bottle shoulders.



### 8.2.2 Specifications for two-piece packaging

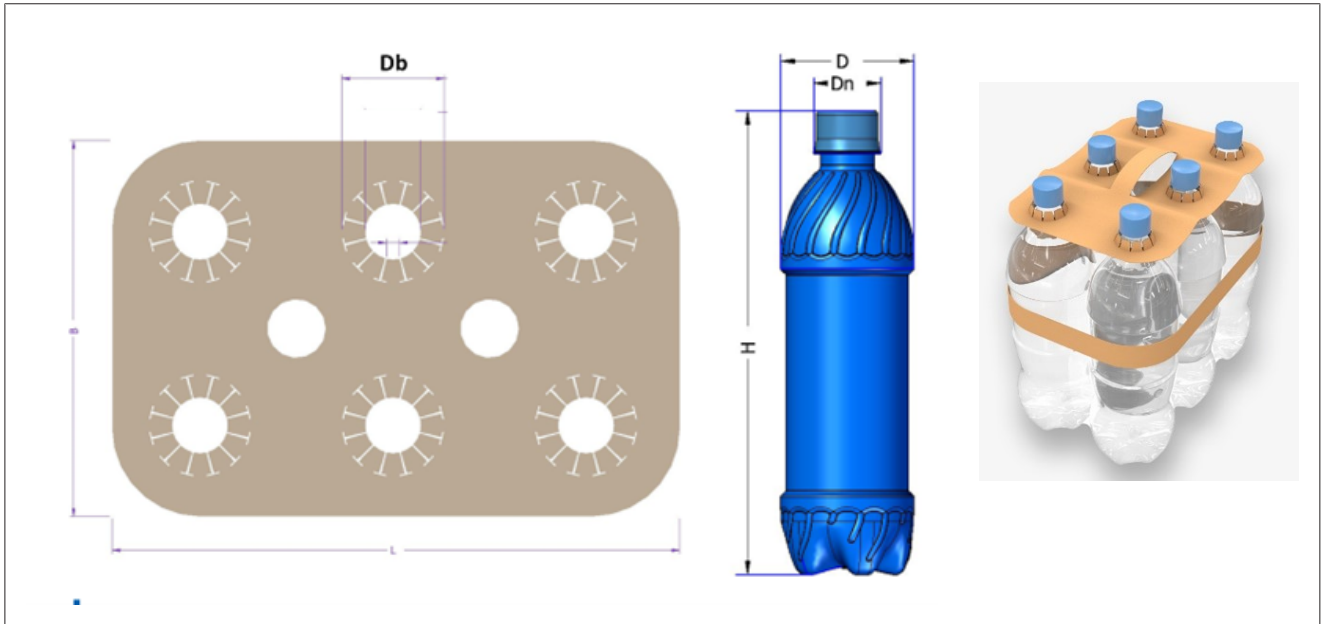

Fig. 144: Dimensions of clip

#### Dimensions:

$$L \leq D \times n$$

$$B \leq D \times n$$

$$Db \geq Dn + 8$$

- L: Length of clip
- B: Width of clip
- D: Outer diameter of bottle
- Dn: Neck ring diameter
- Db: Diameter of bending grooving

The outer dimensions of the clip must not exceed the outer dimensions of the container.

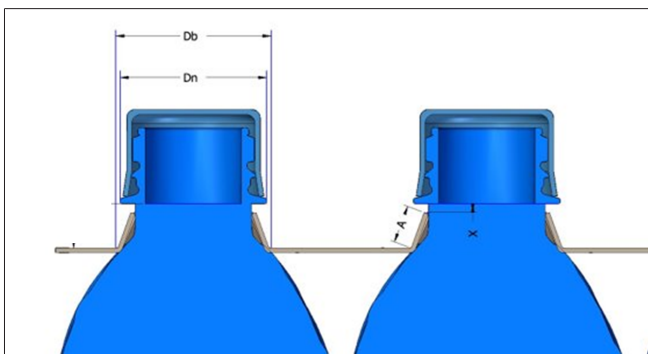

Fig. 145: Flaps of the of the star-shaped cut-out

- X: Required application tolerance  $\geq 4$  mm
- A: Length of the flaps
- Db: Diameter of bending grooving

The length of the flaps A must be selected so that the application tolerance of at least 3 mm is kept if the clip rests on the bottle shoulders.



### 8.2.3 Pick-up surfaces

#### Pick-up surfaces for one single clip

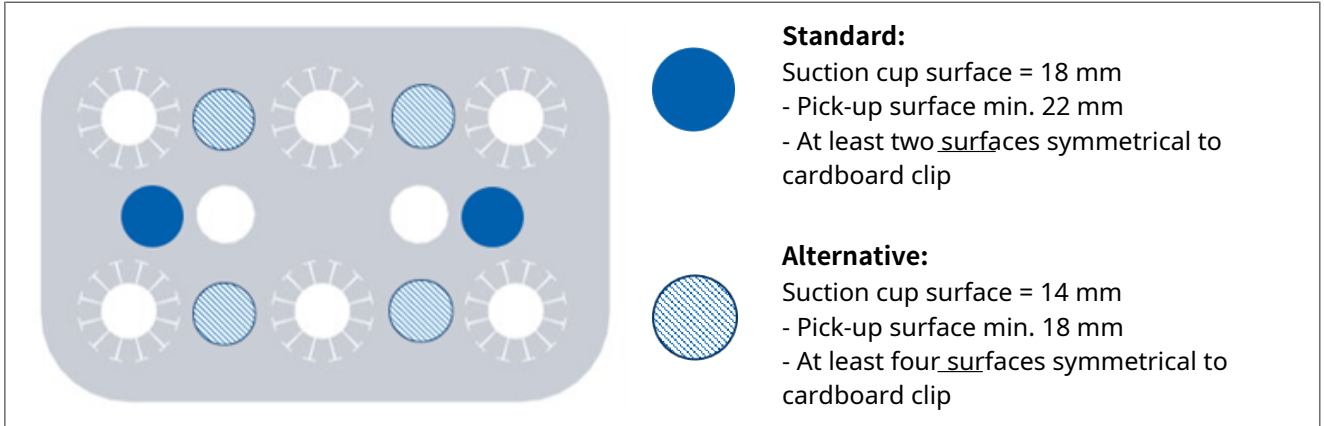

Fig. 146: Pick-up surfaces for one single clip

#### Connected cardboard clips (via microjoints)

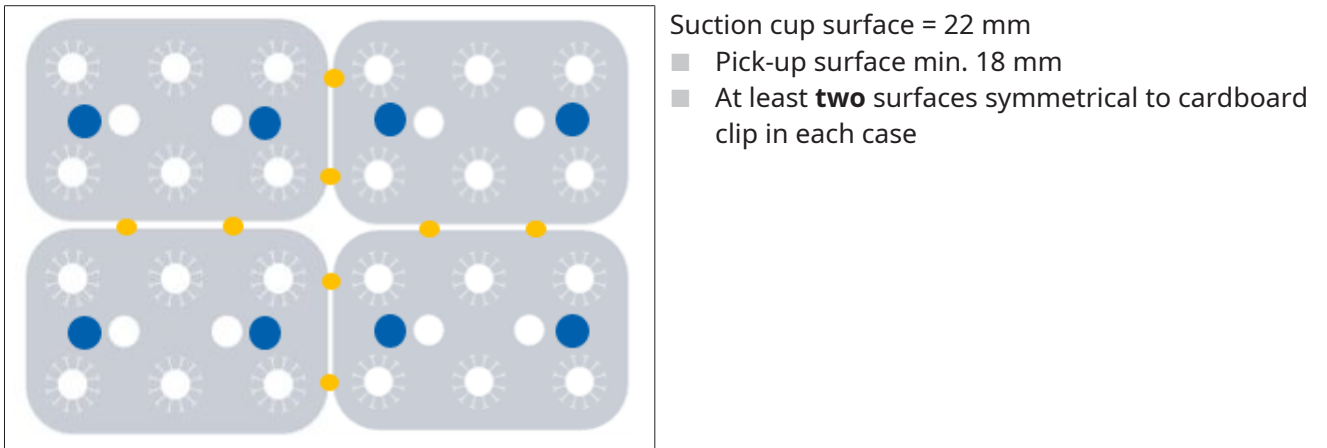

Fig. 147: Example: 6-container cardboard clip, connected via microjoints (yellow)

### 8.2.4 Permissible press-on forces

Application via 24-formation: e.g. clip composite 4 x 6 pack

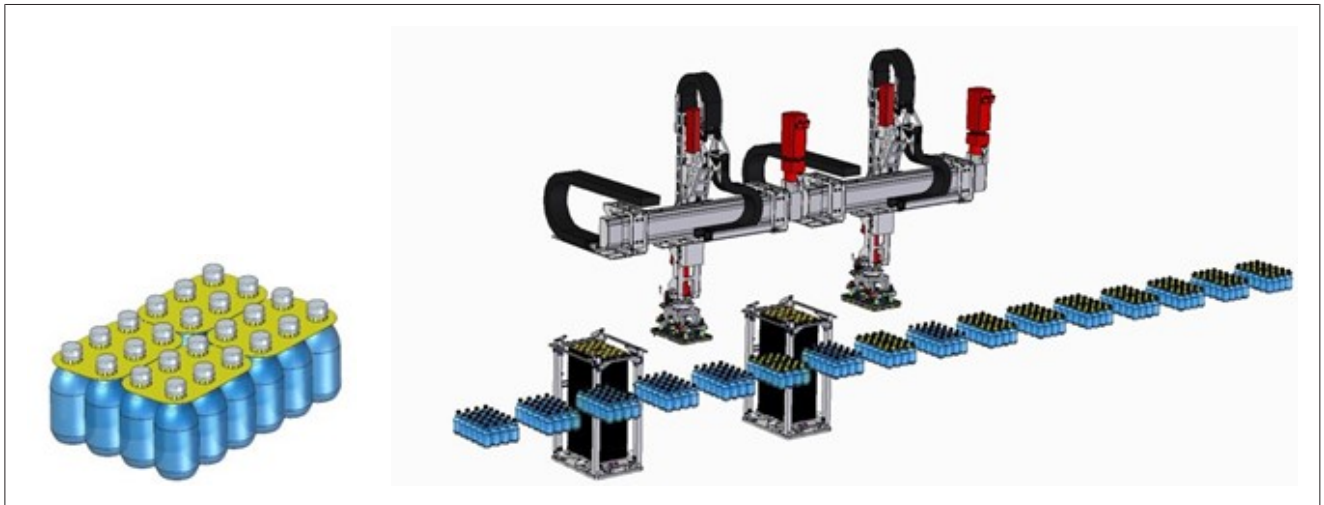

Fig. 148: Variopac - permissible press-on forces

The maximum permissible press-on force amounts to 1200 N.

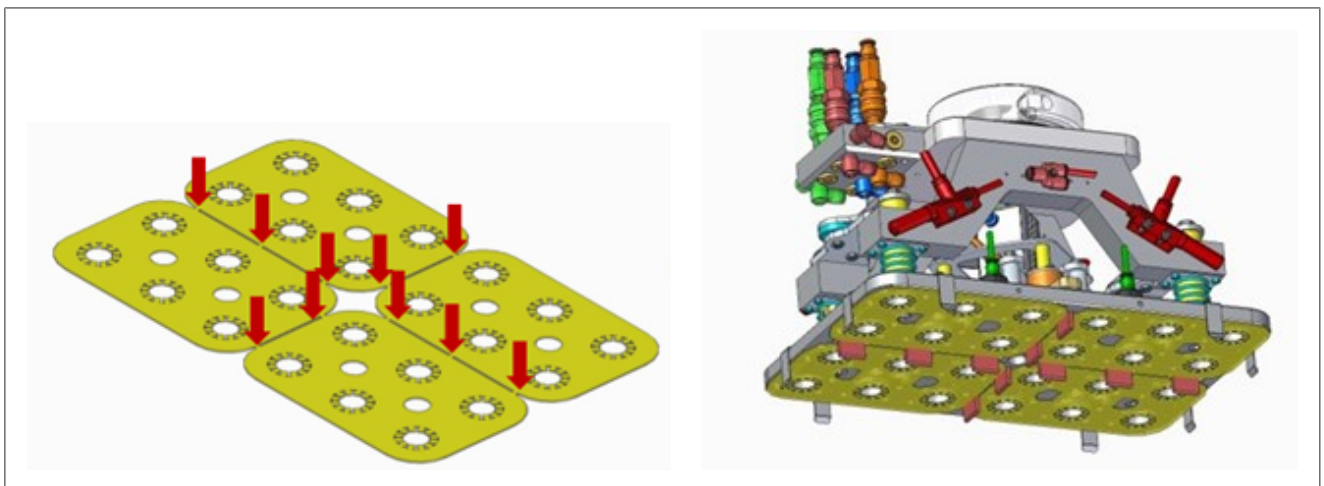

Fig. 149: Variopac - permissible press-on forces

To break/open the clip composite at the microjoints, a maximum force of 250 N is permissible.

## 8.2.5 Magazines

### For single clips:

One magazine for each individual formation of bottles

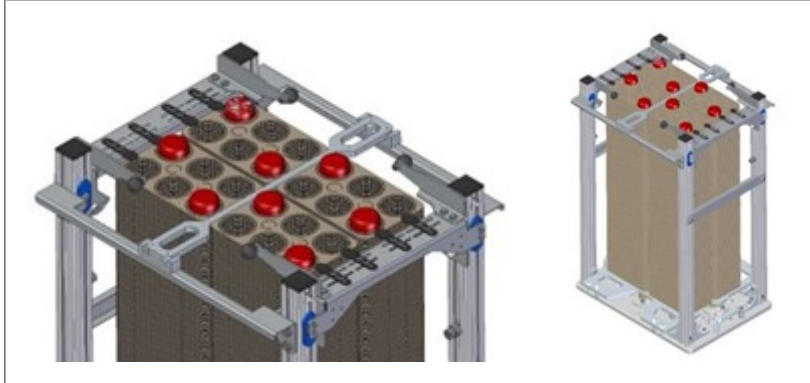

Fig. 150: Variopac - magazine (single clips)

→ Involves more effort for refilling.

### For clip composite:

Usually only one magazine for all formations with the same diameter and number of bottles.

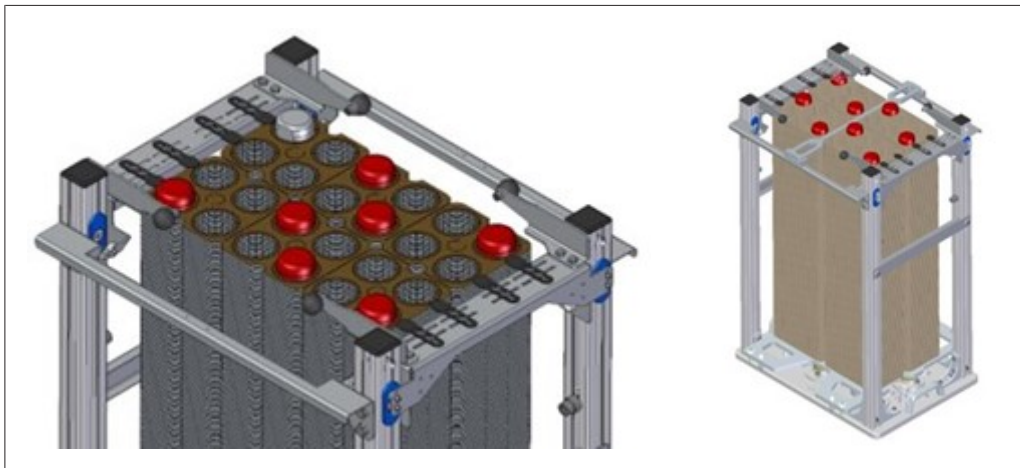

Fig. 151: Variopac - magazine (clip composite)

#### Slanted position

- To prevent slanted positions in the magazine, the clips should have a symmetrical thickness.

#### Machine capacity

- The number of clips to be applied depends strongly on the thickness of the material. The thicker the material, the fewer clips can be stored in the magazine. This results in frequent refills and thus reduces the capacity of the machine.

#### Guide contours

- In the magazine, the clips are guided in a straight line. To ensure guidance, the clip must have simple and/or straight contours. If deviations from simple contours are desired, these require prior consultation with the KRONES Design Department.

## 9 Processing criteria

### 9.1 Suitability of the containers

#### Suitable container



Fig. 152: Suitable container

The long container neck with a smooth transition to shoulder height allows the dividers to be placed onto the container with ease.

#### Special feature of Varioline



Fig. 153: Special feature of Varioline

During the normal sequence, the dividers are placed onto the container. The container shape means that a centring unit for the dividers is not possible because the containers are packed too closely together.

An adequately long bottle neck and a diameter difference between the shoulder height and standing base would be required.

Since the Varioline inserts the dividers at the standard distance before the containers, Varioline enables a centring unit and processing. Consultation with the technical department is required.

### Bottle difficult to protect



Fig. 154: Bottle difficult to protect

The dividers cannot be inserted all the way to the base and cannot therefore protect the containers completely. For this reason, they are pushed upwards.

To compensate for this effect, we recommend the following:

Divider height = Container Height + Closure.

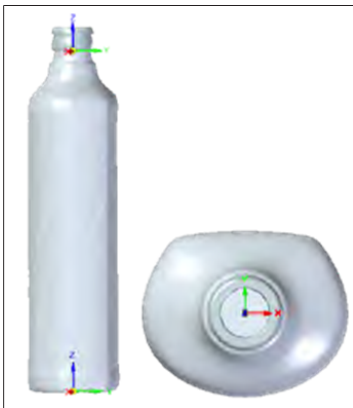

Fig. 155: Container cannot be centred

The dividers cannot be centred because these containers have one straight and one round side.

Consequently, the optimum orientation of the dividers cannot be guaranteed.

## 9.2 Requirements for inserting

### 9.2.1 Varioline

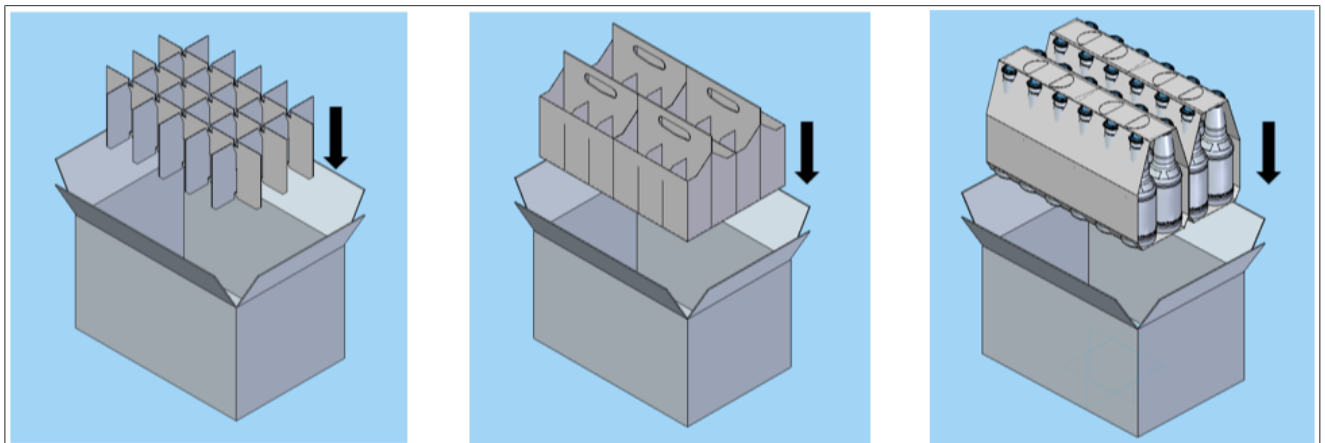

Fig. 156: Inserting

When placing secondary packaging (divider, basket, OTO, etc.) into tertiary packaging (carton with cover flaps, wrap-around carton, tray, etc.), a clearance is defined to prevent problems during insertion.

This means that the tertiary packaging must have a gap of 0-2 mm all around for the divider, 5-15 mm for baskets and 3-20 mm for OTOs to form the secondary packaging.

### NOTICE

**Important:**

When inserting a divider, ensure that the edge strut is at least 4 mm shorter than the cell dimension.



#### 6.4 Requirements for a divider [▶ 46]

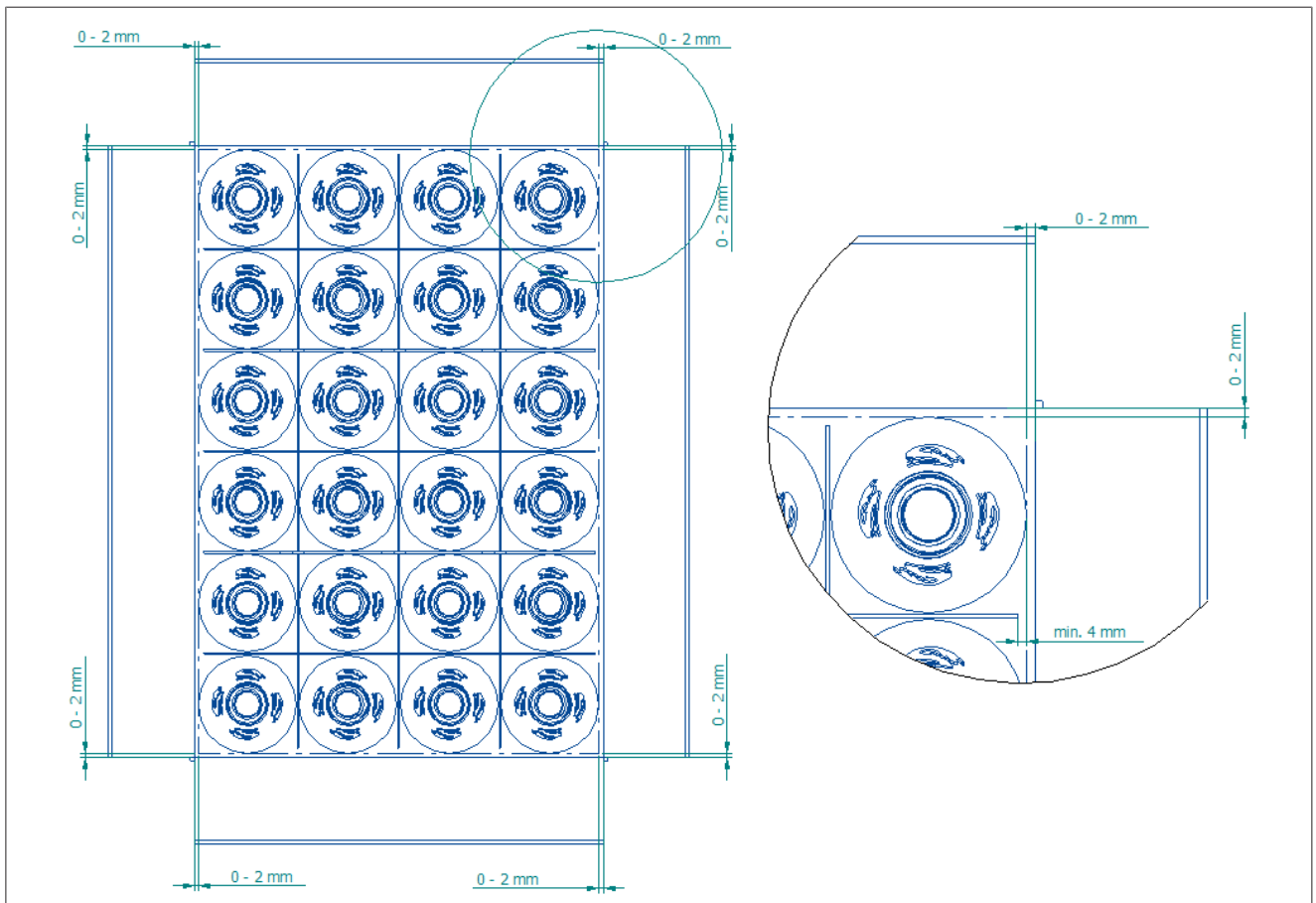

Fig. 157: Gap for insertion of divider



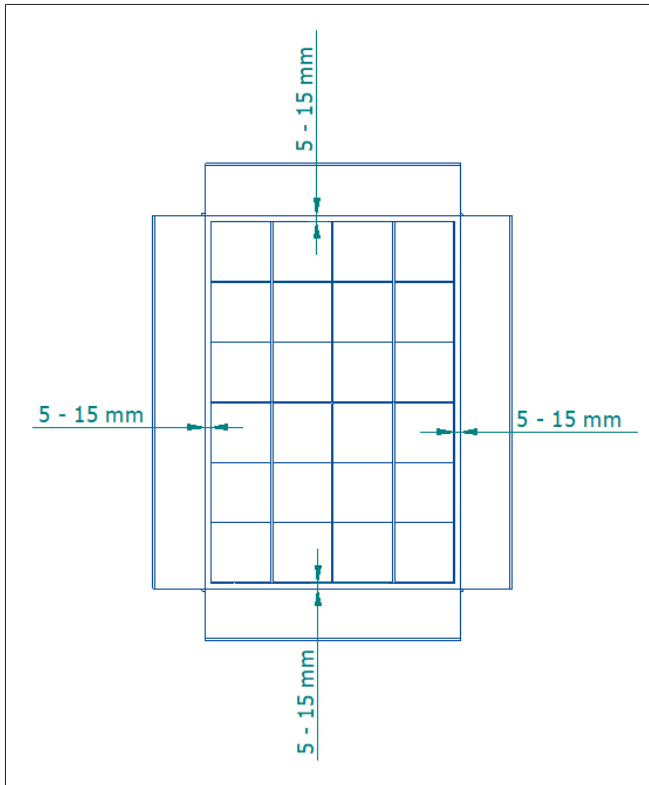

Fig. 158: Gap for insertion of basket

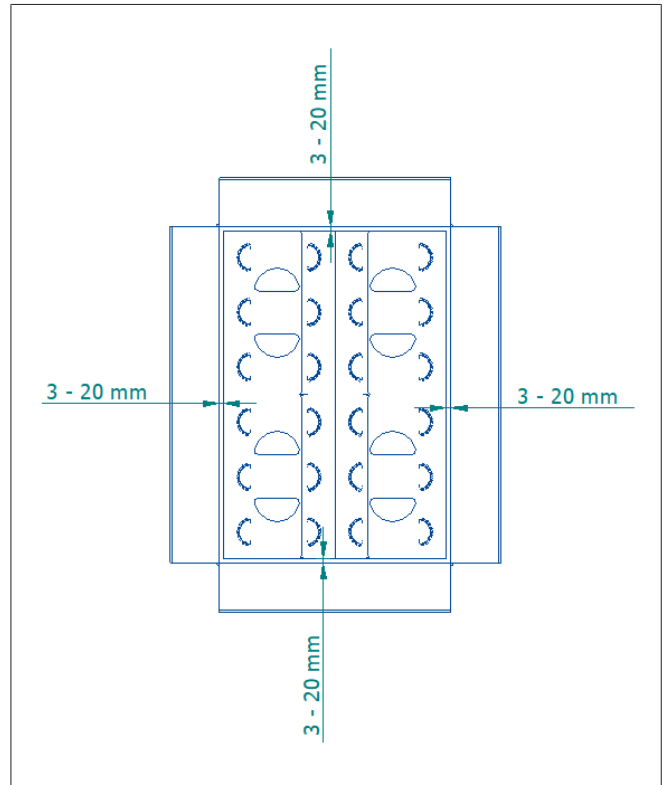

Fig. 159: Gap for insertion of OTO

If the specified area falls short, collisions may occur and if it is exceeded, the products may be too loose in the tertiary packaging and the products may be damaged as a result, for example during transport.

When placing bottles loosely into wrap-around cartons or cartons with cover flaps, NO clearance is required.

### 9.2.2 Variopac

When processing cardboard containers with the Variopac, a distance is only required for the divider. This is the same as for the Varioline. As the packs are formed ("folded around the carton") and counterpressure must also be used, a distance is not practical for this purpose and would therefore even be counterproductive in most cases.



### 9.3 Formation

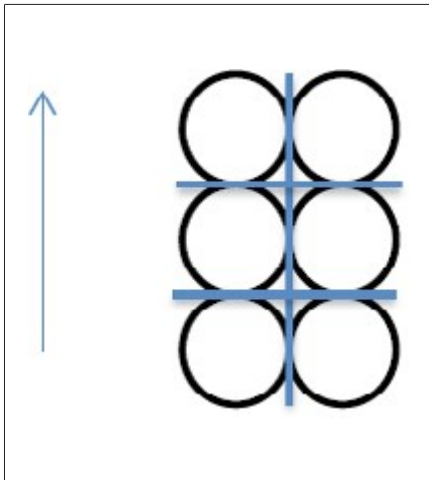

Fig. 160: 3x2 <sup>1)</sup>

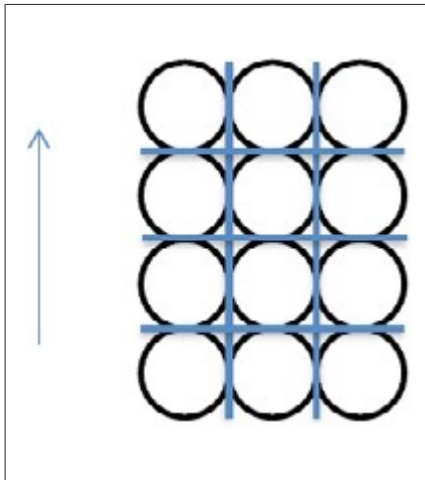

Fig. 161: 4x3

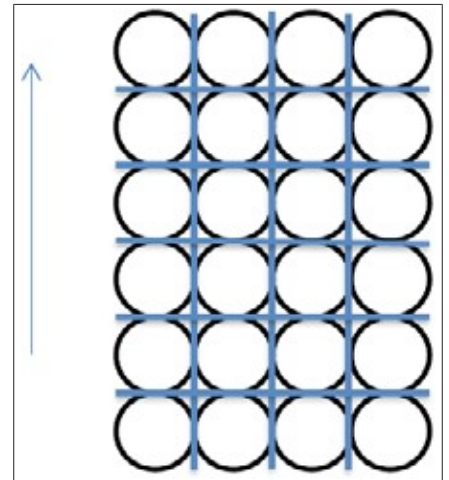

Fig. 162: 6x4 <sup>2)</sup>

<sup>1)</sup> Preferably an E-flute should be used here, as the inherent stability is not adequate for solid board.

<sup>2)</sup> For  $\geq 4$  containers positioned perpendicular to the running direction in combination with label protection, consultation with the technical department is required.

### 9.4 Divider dimensions

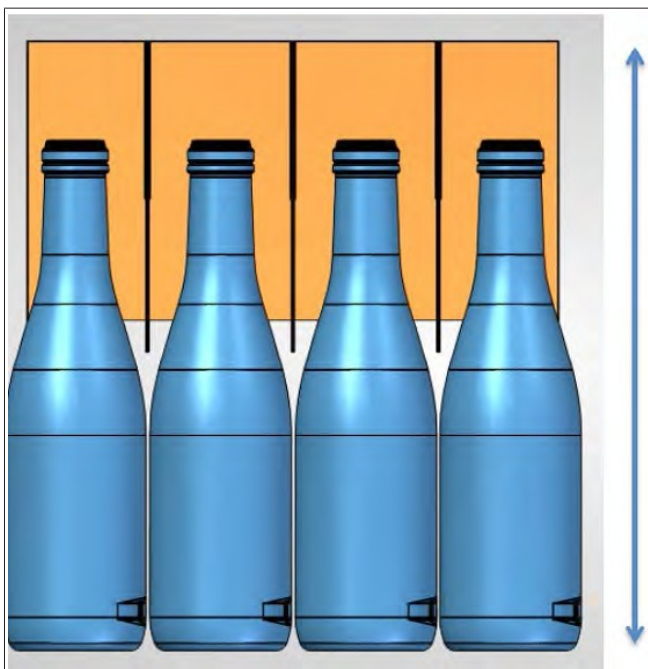

Fig. 163: Divider dimensions

#### NOTICE

The drawing shows the application process, not the final packaging.

Interfering edge = shoulder height + divider height

If double the shoulder height amounts to more than 450 mm, consultation with the technical department is required.

**The standard divider height is equal to the container shoulder height.**